



RAD HARD 3.5A SWITCHING REGULATOR

5044RH

FEATURES:

- Manufactured using  Rad Hard RH1959MILDICE
- Radiation Hardened to 100 Krad(Si) (Method 1019.8 Condition A)
- Improved Replacement for Satcon SAT8565A
- Adjustable Output Voltage Down to 1.21V
- Input Voltage Range from 4.3V to 16V
- Constant 500KHz Switching Frequency
- Shutdown Pin
- Short Circuit and Thermal Limit Protection
- Available in 4 Lead Form Options: Straight, Up, Down and Gull Wing
- Available to DLA SMD 5962R11231
- Single Event Effect Tested

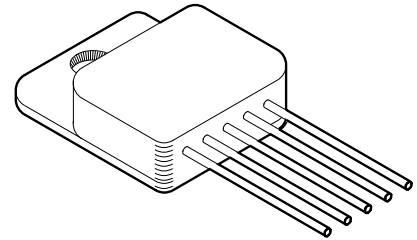

DESCRIPTION:

The MSK5044RH is a radiation hardened adjustable output voltage switching regulator. A wide input and output voltage range with 3.5A output current capability make these regulators suitable for many applications. Excellent efficiency and a reduced output capacitance requirement are the results of a constant 500KHz switching frequency. The regulator output can be turned on and off remotely with low current logic levels via the shutdown pin for meeting power sequencing requirements. Short circuit current limit and thermal shutdown features provide fault protection. The MSK5044RH is hermetically sealed in a space saving 5 pin power package and specifically designed for space/satellite applications.

EQUIVALENT SCHEMATIC

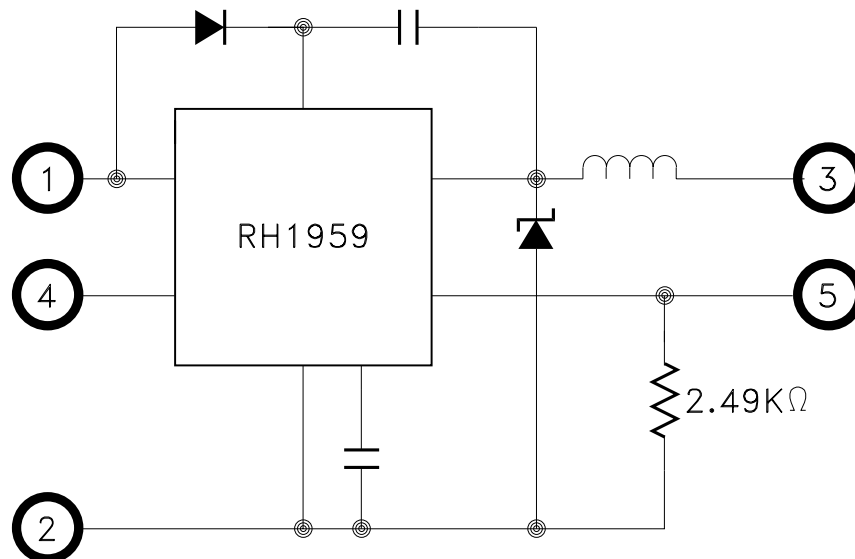

TYPICAL APPLICATIONS

- POL Applications
- Satellite System Power Supply
- Microprocessor, FPGA Power Source
- High Efficiency Low Voltage Subsystem
- Power Supply

PIN-OUT INFORMATION

- | | |
|---|------|
| 1 | VIN |
| 2 | GND |
| 3 | VOUT |
| 4 | SHDN |
| 5 | FB |

CASE = ISOLATED

 and the Linear Technology logo are registered trademarks and RH1959MILDICE is a copyright of Linear Technology Corporation

ABSOLUTE MAXIMUM RATINGS

⑧

VIN	Input Voltage	16V	T _{ST}	Storage Temperature Range⑫.....	-65°C to +150°C
I _{OUT}	Output Current⑧.....	4A	T _{LD}	Lead Temperature Range ⑩ (10 Seconds)	300°C
	$\overline{\text{SHDN}}$ Pin Voltage	7.0V	T _J	Junction Temperature	150°C
			T _C	Case Operating Temperature Range MSK5044K/H RH	-55°C to +125°C
				MSK5044RH	-40°C to +85°C
				ESD Rating	3A

ELECTRICAL SPECIFICATIONS

Parameter	Test Conditions ① ⑩	Group A Subgroup	MSK5044K/HRH			MSK5044RH			Units
			Min.	Typ.	Max.	Min.	Typ.	Max.	
Feedback Voltage (V _{FB})		1, 2, 3	1.19	1.21	1.23	1.19	1.21	1.23	V
	Post 100 Krad(Si)	1	1.17	-	1.24	1.17	-	1.24	V
Line Regulation	4.3V ≤ VIN ≤ 15V	1, 2, 3	-0.5	-	0.5	-0.5	-	0.5	%
Load Regulation	1A ≤ I _{OUT} ≤ 3A	1, 2, 3	-1.0	-	1.0	-1.0	-	1.0	%
VIN Input Supply Range ② ③		1, 2, 3	4.3	-	15.0	4.3	-	15.0	V
Output Voltage Range ②	VIN = 10.0V ΔV _{FB} = 1%	1, 2, 3	-	9.1	-	-	9.1	-	V
Efficiency		1, 2, 3	75	81.5	-	75	81.5	-	%
Output Voltage Ripple ②		-	-	22	-	-	22	-	mVpp
Switching Frequency		4	460	500	540	460	500	540	KHz
		5, 6	440	-	560	-	-	-	KHz
	Post 100 Krad(Si)	4	410	-	540	410	-	540	KHz
Current Limit ⑧		1, 2, 3	3.5	4.4	-	3.5	4.4	-	A
VIN Supply Current @ Shutdown (low power state)	$\overline{\text{VSHDN}} = 0\text{V}$	1, 2, 3	-	41	75	-	41	75	uA
Shutdown Threshold Voltage (low power state)		1, 2, 3	0.13	0.40	0.60	0.13	0.40	0.60	V
Thermal Resistance ②	Junction to Case @ 125°C Forward Switch	-	-	13.4	14.0	-	13.4	14.0	°C/W
Thermal Resistance ②	Junction to Case @ 125°C Catch Diode	-	-	18.7	20	-	18.7	20	°C/W

NOTES:

- ① Unless otherwise specified VIN = 5.0V, V_{OUT} = 2.5V and I_{OUT} = 1.0A. See Figure 1 for typical application circuit.
- ② Guaranteed by design but not tested. Typical parameters are representative of actual device performance but are for reference only.
- ③ Verified during line regulation test.
- ④ Industrial grade devices shall be tested to subgroup 1 and 4 unless otherwise specified.
- ⑤ Military grade devices ("H" Suffix) shall be 100% tested to subgroups 1,2,3 and 4.
- ⑥ Subgroup 5 & 6 testing available on request.
- ⑦ Subgroup 1,4 TA = TC = +25°C
2,5 TA = TC = +125°C
3,6 TA = TC = -55°C
- ⑧ The output current limit function provides protection from transient overloads but it may exceed the maximum continuous rating. Continuous operation in current limit may damage the device. The absolute maximum current of 4.0A applies at duty cycles of 0.75 and lower. De-rate linearly from 4.0A at D = 0.75 to 3.0A at D = 1.0.
- ⑨ Continuous operation at or above absolute maximum ratings may adversely effect the device performance and/or life cycle.
- ⑩ The internal case temperature must not exceed 175°C under any conditions.
- ⑪ Pre and Post irradiation limits at 25°C, up to 100 Krad(Si) TID, are identical unless otherwise specified.
- ⑫ Internal solder reflow temperature is 180°C, do not exceed.
- ⑬ Reference DLA SMD 5962R11231 for electrical specification for devices purchased as such.

APPLICATION NOTES

PIN FUNCTIONS

VIN - VIN connects to the collector of the internal power switch and provides power to the internal control circuitry and internal regulator. Very high di/dt is seen at VIN during switch on and off transitions. High frequency decoupling capacitors mounted in close proximity to the VIN and ground pins are recommended to minimize voltage spikes. VIN should be connected to a low impedance source for best operation.

FB - The FB (feedback) pin's primary function is to set the output voltage to the desired level. Use a single resistor between VOUT and FB to form a feedback divider network with the internal 2.49K resistor. Select the external resistor value to set the voltage at the FB pin to 1.21V when the output is at the desired level, see "Setting The Output Voltage". The FB pin provides two additional functions. If the voltage at the FB pin drops below 0.8V the switch current limit is reduced. When the voltage at the FB pin drops below 0.7V the switching frequency is reduced. The switching frequency reduces to approximately 100KHz at $V_{FB} < 0.4V$.

GND - The GND pin provides a return path for all internal control current and acts as a reference to the error amplifier. It is important that it is at the same voltage potential as the load return to ensure proper regulation. Keep current on the ground between the load and the MSK5044RH to a minimum and use heavy copper traces to minimize voltage drops and regulation error.

SHDN - The SHDN (shutdown) pin has two shutdown functions. The first function disables switching when the voltage on the pin drops below 2.38V (nominal). The second forces a complete shutdown minimizing power consumption when the voltage drops below 0.4V (nominal). Pull this pin high or leave open for normal operation. The 2.38V threshold can be used for UVLO functions by configuring a resistive divider to VIN and GND that holds the pin voltage below 2.38V until VIN rises to the minimum desired voltage.

VOUT - VOUT is the output of the regulator. External capacitance between the VOUT pin and GND is required to maintain stability and minimize output ripple voltage, see "Selecting The Output Capacitor." Provide a low impedance path between VOUT and the load to minimize voltage drops.

SETTING THE OUTPUT VOLTAGE

The output voltage of the MSK5044RH is set with a single resistor, see Figure 1 (Typical Application Circuit). Select the value of RFB using the formulas below.

$$V_{OUT} = V_{FB} * (1 + R_{FB} / 2490)$$

$$R_{FB} = 2490 * ((V_{OUT} / V_{FB}) - 1)$$

Given $V_{FB} = 1.21V$ Nominal

TYPICAL APPLICATION CIRCUIT

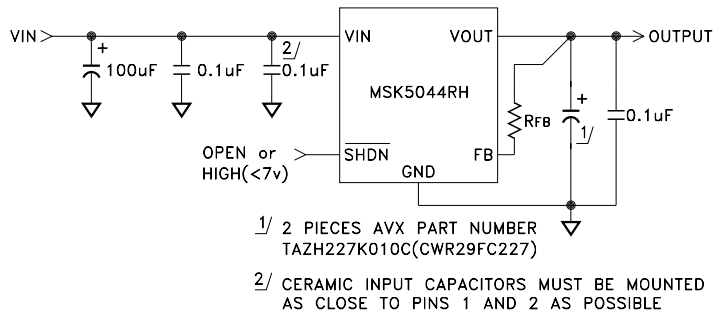

FIGURE 1

SELECTING THE OUTPUT CAPACITOR

The output capacitor filters the ripple current from the internal inductor to an acceptable ripple voltage seen by the load. The primary factor in determining voltage ripple is the ESR of the output capacitor. The voltage ripple can be approximated as follows:

$$V_{P-P} = I_{P-P} * ESR$$

$$\text{Where } I_{P-P} = V_{OUT} * (V_{IN} - V_{OUT}) / (1.65 * V_{IN})$$

The typical ESR range for an MSK5044RH application is between 0.05 and 0.20 ohm. Capacitors within these ESR ranges typically have enough capacitance value to make the capacitive term of the ripple equation insignificant. The capacitive term of the output voltage ripple lags the ESR term by 90° and can be calculated as follows:

$$V_{P-P}(CAP) = I_{P-P} / (8 * F * C)$$

Where:

C = output capacitance in Farads

F = Switching Frequency in Hertz

Select a capacitor or combination of capacitors that can tolerate the worst-case ripple current with sufficient de-rating. When using multiple capacitors in parallel to achieve ESR and/or total capacitance, sharing of ripple current between capacitors will be approximately equal if all of the capacitors are the same type and preferably from the same lot. Low ESR tantalum capacitors are recommended over aluminum electrolytic. The zero created by the ESR of the capacitor is necessary for loop stability. A small amount of ceramic capacitance close to the load to decouple high frequency is acceptable but it should not cancel the ESR zero.

APPLICATION NOTES CONT'D

CURRENT LIMIT

The MSK5044RH typically current limits at 3.75A. The output voltage will begin to drop when the current limit is reached. If the output voltage drops below 66% of the programmed level the output current limit level will be reduced to protect a shorted or latched up load circuit from a continuous high current condition. The current limit reduction is controlled by the voltage at feedback pin and can be defeated if it is undesired. A simple clamp circuit to prevent the feedback voltage from dropping below a nominal 0.8V will prevent the fold back current condition. The foldback occurs when the feedback voltage drops below 0.8V and the normal in regulation feedback voltage is 1.21V. Clamping the feedback pin to a voltage between 0.9V and 1.1V prevents foldback and allows normal regulation. Clamping the feedback pin will also defeat the frequency shift that occurs when the feedback voltage drops below 0.7V

TOTAL DOSE RADIATION AND SEE TEST PERFORMANCE

Radiation performance curves for TID testing are generated for all radiation testing performed by TTM Technologies. These curves show performance trends throughout the TID test process and are located in the MSK5044RH radiation test report. The complete radiation test report is available in the RAD HARD PRODUCTS section on the MSK website. Contact TTM Technologies for SEE test results.

TYPICAL PERFORMANCE CURVES

FEEDBACK PIN VOLTAGE vs CASE TEMPERATURE

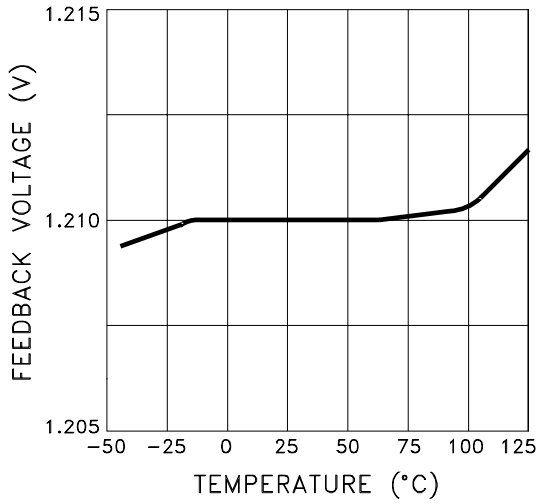

LOCKOUT AND SHUTDOWN THRESHOLDS vs JUNCTION TEMPERATURE

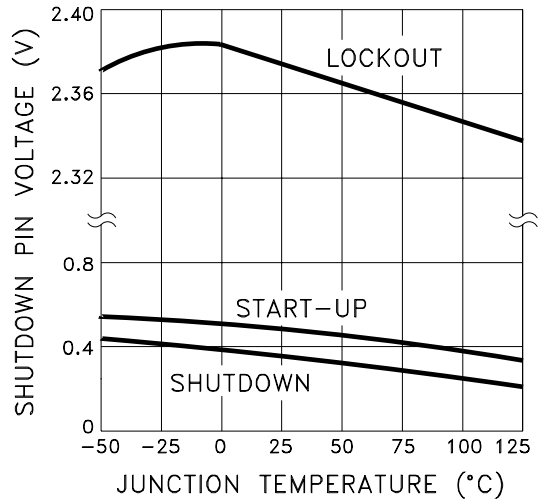

EFFICIENCY vs. LOAD CURRENT

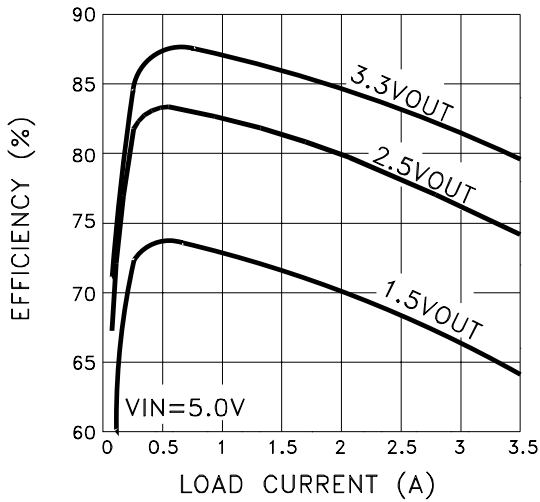

SWITCHING FREQUENCY

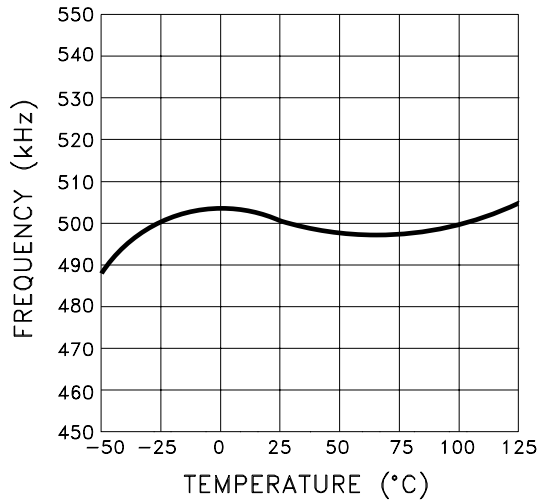

SHUTDOWN PIN BIAS CURRENT

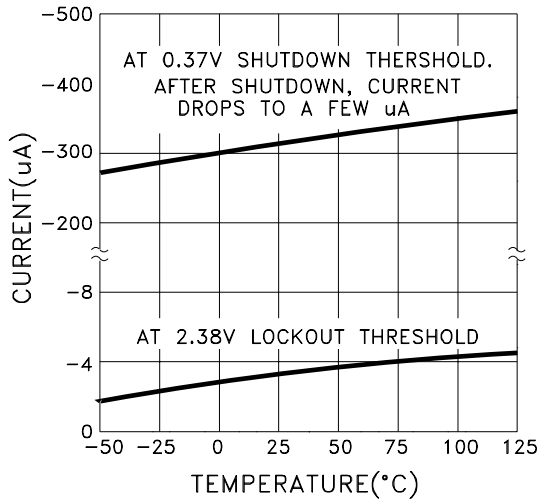

SHUTDOWN VIN SUPPLY CURRENT

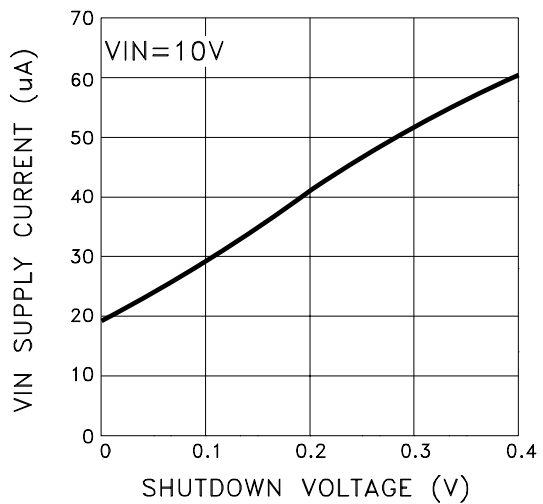

TYPICAL PERFORMANCE CURVES CONT'D

CURRENT LIMIT vs INPUT VOLTAGE

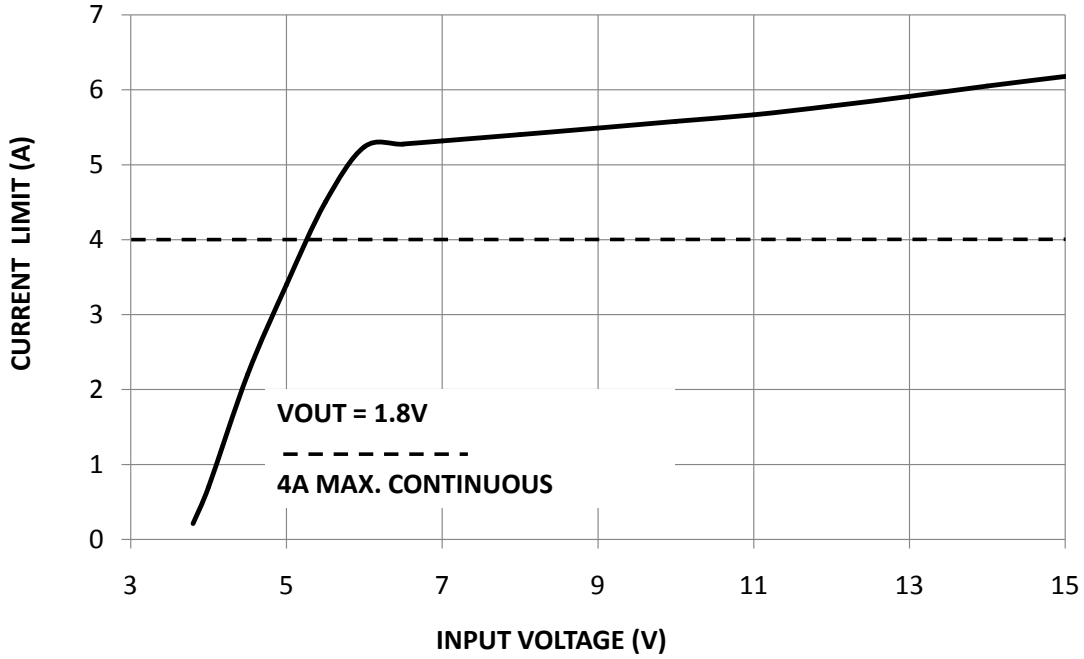

CURRENT LIMIT vs INPUT VOLTAGE

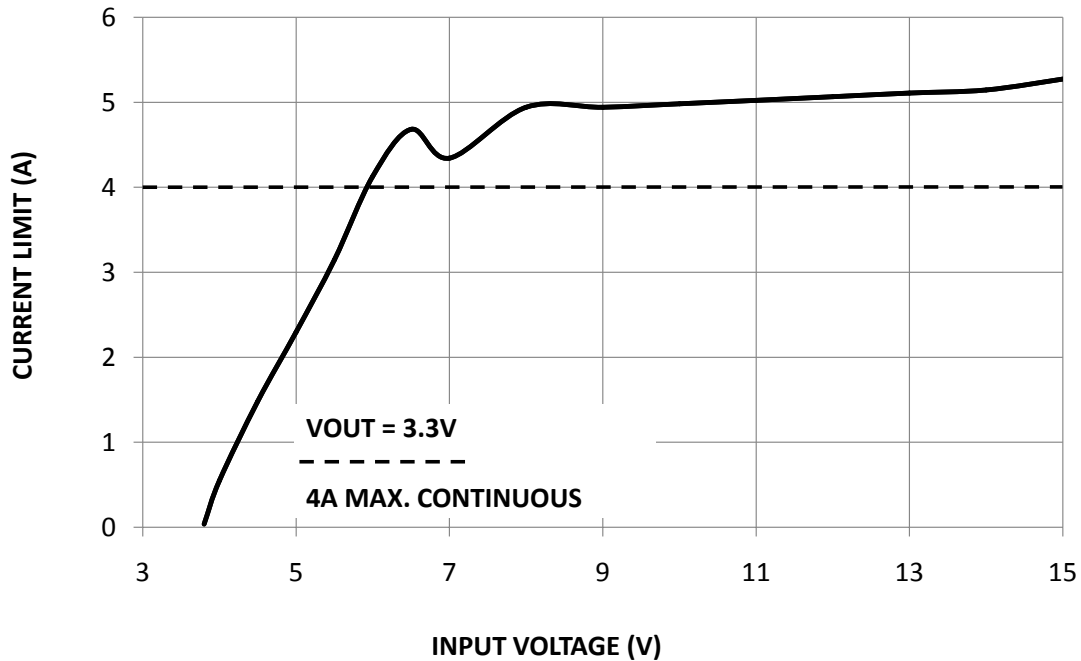

TYPICAL PERFORMANCE CURVES CONT'D

GAIN AND PHASE RESPONSE

The gain and phase response curves are for the MSK typical application circuit and are representative of typical device performance, but are for reference only. The performance should be analyzed for each application to insure individual program requirements are met. External factors such as temperature, input and output voltages, capacitors, etc. all can be major contributors. Please consult factory for additional details.

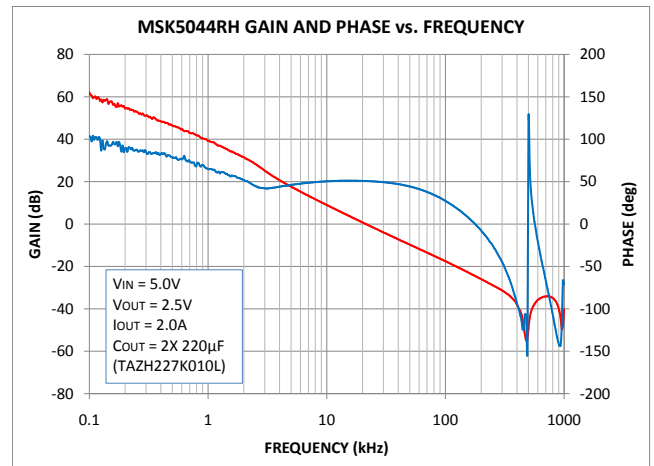
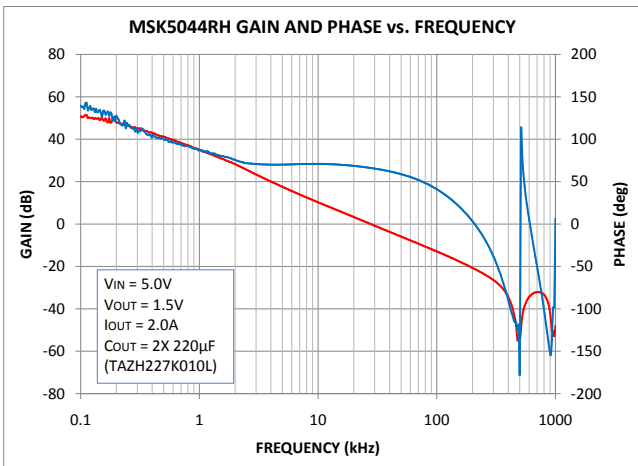
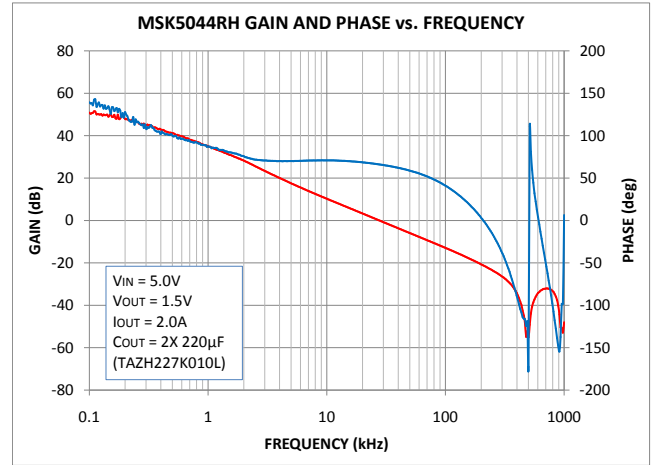
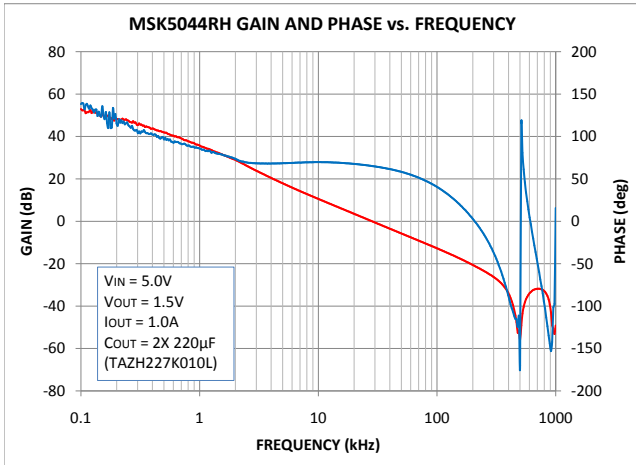

MECHANICAL SPECIFICATIONS

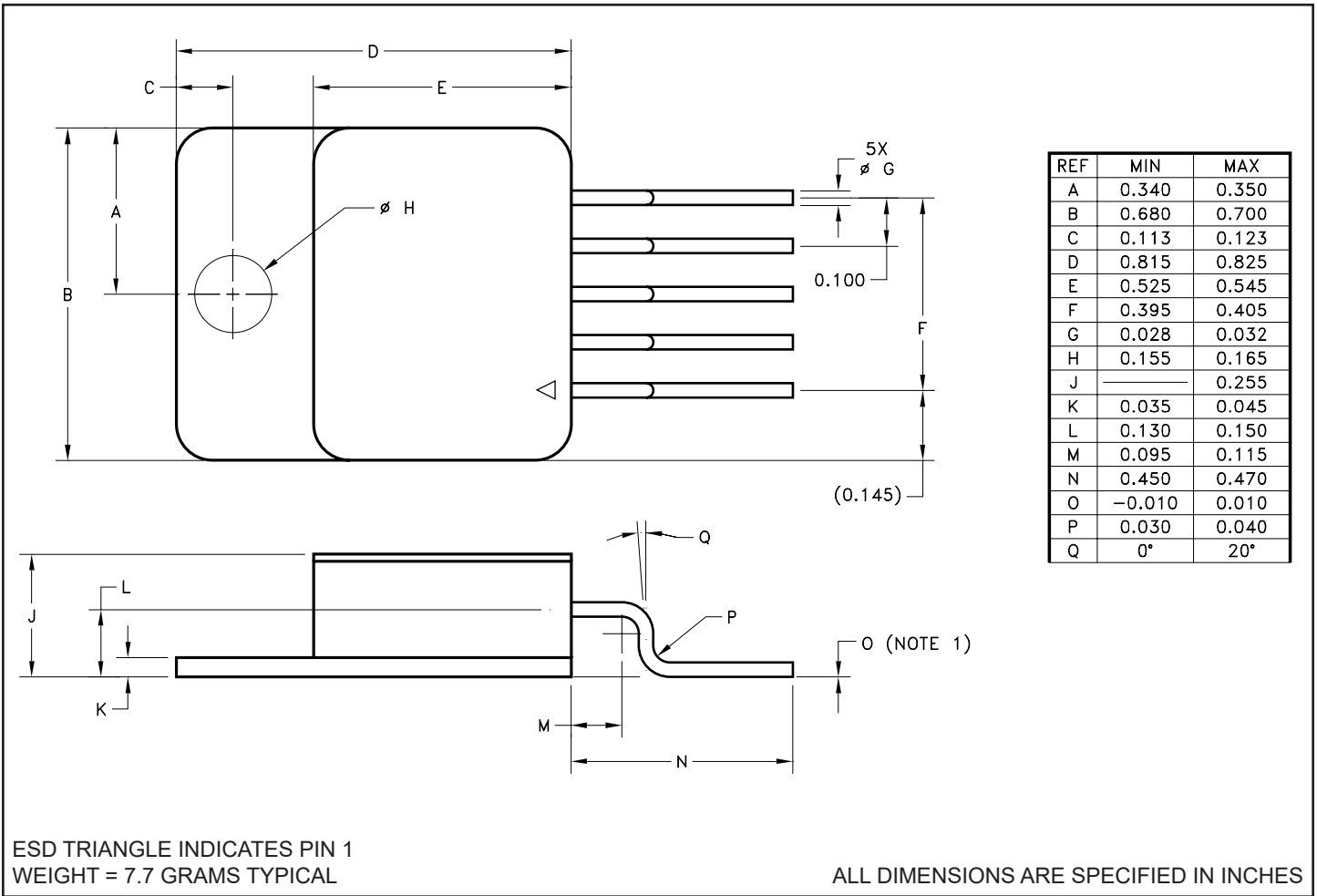

ORDERING INFORMATION

MSK5044 K RH GW

LEAD CONFIGURATIONS

GW = GULL WING

RADIATION HARDENED

SCREENING

BLANK = INDUSTRIAL; H = MIL-PRF-38534 CLASS H;

K = MIL-PRF-38534 CLASS K

GENERAL PART NUMBER

The above example is a Class K switching regulator with gull wing leads.

NOTE: See DLA SMD 5962R11231 for DLA part number options.

MECHANICAL SPECIFICATIONS

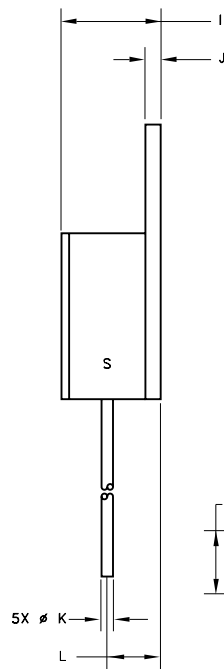
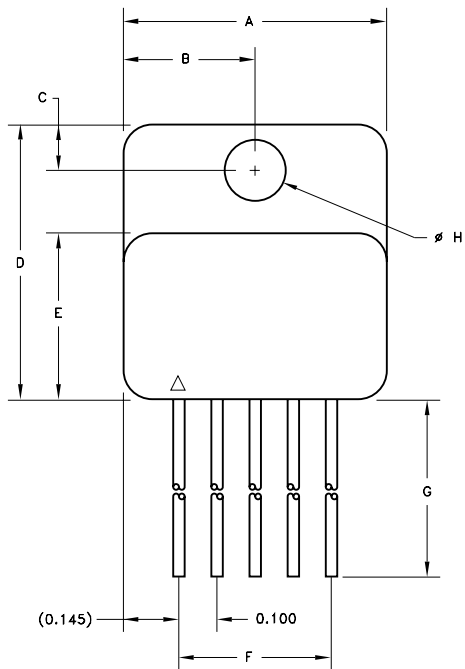

REF	MIN	MAX
A	0.680	0.700
B	0.340	0.350
C	0.113	0.123
D	0.815	0.825
E	0.525	0.545
F	0.395	0.405
G	0.500	
H	0.155	0.165
I		0.255
J	0.035	0.045
K	0.028	0.032
L	0.130	0.150
M	0.185	0.215
N	0.330	

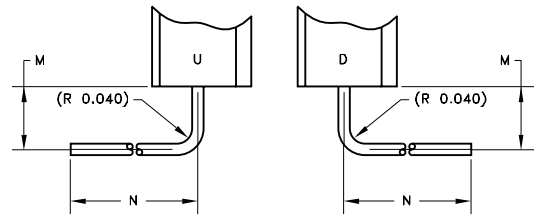

ESD TRIANGLE INDICATES PIN 1
WEIGHT = 7.6 GRAMS TYPICAL

ALL DIMENSIONS ARE SPECIFIED IN INCHES

ORDERING INFORMATION

MSK5044 K RH U

LEAD CONFIGURATIONS

S = STRAIGHT; U = BENT UP; D = BENT DOWN

RADIATION HARDENED

SCREENING

BLANK = INDUSTRIAL; H = MIL-PRF-38534 CLASS H;

K = MIL-PRF-38534 CLASS K

GENERAL PART NUMBER

The above example is a Class K switching regulator with leads bent up.

NOTE: See DLA SMD 5962R11231 for DLA part number options.

REVISION HISTORY

REV	STATUS	DATE	DESCRIPTION
H	Released	08/14	Format update, add internal note and clarify mechanical specifications
J	Released	12/14	Correct adjustable output voltage typo in features list
K	Released	12/14	Add ESD rating and update format
L	Released	02/15	Clarify maximum current rating
M	Released	03/22	Remove MIL-PRF-38535, update company name and website

TTM Technologies
www.ttmtech.com

The information contained herein is believed to be accurate at the time of printing. TTM Technologies reserves the right to make changes to its products or specifications without notice, however and assumes no liability for the use of its products. Please visit our website for the most recent revision of this data sheet.