



RAD HARD 3.5A SWITCHING REGULATOR

5048RH

FEATURES:

- Manufactured using  Rad Hard RH1959MILDICE
- Radiation Hardened to 100 Krad(Si) (Method 1019.8 Condition A)
- Improved Replacement for Satcon SAT8565P
- Adjustable Output Voltage Down to 1.21V
- Input Voltage Range from 4.3V to 16V
- 500KHz or Externally Synchronizable Switching Frequency
- Short Circuit and Thermal Limit Protection
- Available in 3 Lead Form Options: Straight, Down and Gull Wing
- Available to DLA SMD 5962R11232
- Single Event Effect Tested

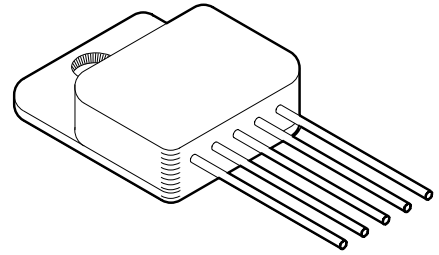

DESCRIPTION:

The MSK5048RH is a radiation hardened adjustable output voltage switching regulator. A wide input and output voltage range with 3.5A output current capability make these regulators suitable for many applications. Excellent efficiency and a reduced output capacitance requirement are the results of a constant or synchronizable switching frequency. The switching frequency can be controlled by an external signal through the SYNC pin or be set to a constant 500KHz. Short circuit current limit and thermal shutdown features provide fault protection. The MSK5048RH is hermetically sealed in a space saving 5 pin power package and specifically designed for space/satellite applications.

EQUIVALENT SCHEMATIC

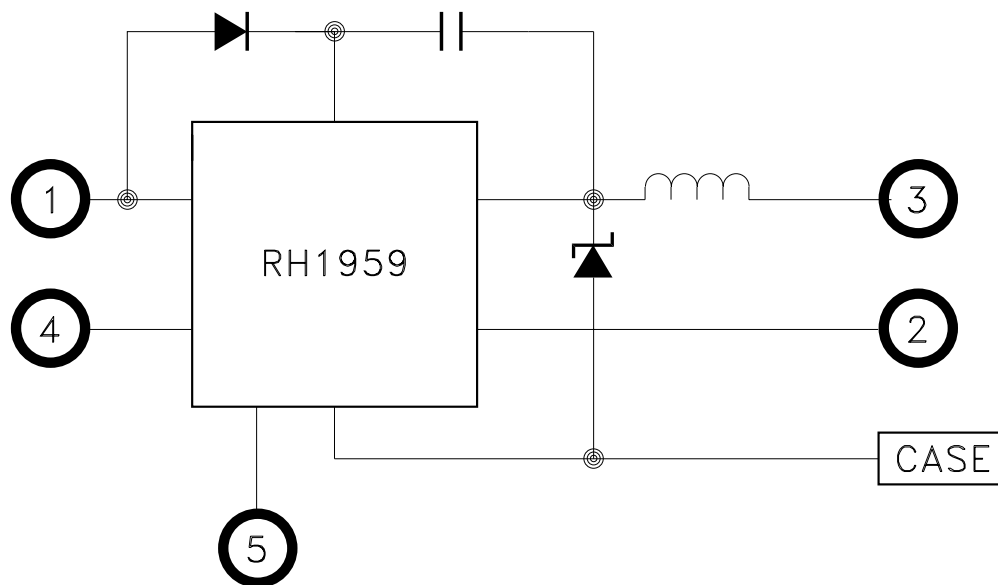

TYPICAL APPLICATIONS

- POL Applications
- Satellite System Power Supply
- Microprocessor, FPGA Power Sourc
- High Efficiency Low Voltage Subsystem
- Power Supply

PIN-OUT INFORMATION

- 1 VIN
- 2 FB
- 3 VOUT
- 4 SYNC
- 5 COMP
- CASE GND

ABSOLUTE MAXIMUM RATINGS

⑩

V _{IN}	Input Voltage	16V	T _{ST}	Storage Temperature Range⑪.....	-65°C to +150°C
I _{OUT}	Output Current⑨.....	4A	T _{LD}	Lead Temperature Range ⑪ (10 Seconds)	300°C
	SYNC Pin Voltage	7.0V	T _J	Junction Temperature	150°C
			T _C	Case Operating Temperature Range MSK5048K/HRH	-55°C to +125°C
				MSK5048RH	-40°C to +85°C
				ESD Rating	3A

ELECTRICAL SPECIFICATIONS

Parameter	Test Conditions ① ⑫	Group A Subgroup	MSK5048K/HRH			MSK5048RH			Units
			Min.	Typ.	Max.	Min.	Typ.	Max.	
Feedback Voltage (V _{FB})		1, 2, 3	1.19	1.21	1.23	1.19	1.21	1.23	V
	Post 100 Krad(Si)	1	1.17	-	1.24	1.17	-	1.24	V
Line Regulation	4.3V ≤ V _{IN} ≤ 15V	1, 2, 3	-0.5	-	0.5	-0.5	-	0.5	%
Load Regulation	1A ≤ I _{OUT} ≤ 3A	1, 2, 3	-1.0	-	1.0	-1.0	-	1.0	%
V _{IN} Input Supply Range ② ④		1, 2, 3	4.3	-	15.0	4.3	-	15.0	V
Output Voltage Range ②	V _{IN} = 10.0V ΔV _{FB} = 1%	1, 2, 3	-	9.1	-	-	9.1	-	V
Efficiency		1, 2, 3	75	82	-	75	82	-	%
Output Voltage Ripple ②		-	-	25	-	-	25	-	mVpp
Switching Frequency	SYNC pin grounded	4	460	500	540	460	500	540	KHz
		5, 6	440	500	560	-	-	-	KHz
		Post 100 Krad(Si)	4	410	-	540	410	-	540
Synchronization Threshold ②		1, 2, 3	-	1.5	2.2	-	1.5	2.2	V
Synchronization Range ③	580KHz ≤ SYNC ≤ 1MHz	7	-	-	-	-	-	-	P/F
		8A, 8B	-	-	-	-	-	-	P/F
Current Limit ⑨		1, 2, 3	3.5	-	-	3.5	-	-	A
Thermal Resistance ②	Junction to Case @ 125°C Forward Switch	-	-	13.4	14.0	-	13.4	14.0	°C/W
Thermal Resistance ②	Junction to Case @ 125°C Catch Diode	-	-	18.7	20	-	18.7	20	°C/W

NOTES:

- ① Unless otherwise specified V_{IN} = 5.0V, V_{OUT} = 2.5V and I_{OUT} = 1.0A. See Figure 2 for typical application circuit.
- ② Guaranteed by design but not tested. Typical parameters are representative of actual device performance but are for reference only.
- ③ Reference SYNC pin function in the Application Notes section herein.
- ④ Verified during line regulation test.
- ⑤ Industrial grade and devices shall be tested to subgroup 1 and 4 unless otherwise specified.
- ⑥ Military grade devices ("H" Suffix) shall be 100% tested to subgroups 1,2,3 and 4.
- ⑦ Subgroup 5 & 6 testing available on request.
- ⑧ Subgroup 1, 4, 7 TA = TC = +25°C
2, 5, 8A TA = TC = +125°C
3, 6, 8B TA = TC = -55°C
- ⑨ The output current limit function provides protection from transient overloads but it may exceed the maximum continuous rating. Continuous operation in current limit may damage the device. The absolute maximum current of 4.0A applies at duty cycles of 0.75 and lower. De-rate linearly from 4.0A at D = 0.75 to 3.0A at D = 1.0.
- ⑩ Continuous operation at or above absolute maximum ratings may adversely effect the device performance and/or life cycle.
- ⑪ Internal solder reflow temperature is 180°C, do not exceed.
- ⑫ Pre and Post irradiation limits at 25°C, up to 100 Krad(Si) TID, are identical unless otherwise specified.
- ⑬ Reference DLA SMD 5962R11232 for electrical specification for devices purchased as such.

APPLICATION NOTES

PIN FUNCTIONS

VIN - VIN connects to the collector of the internal power switch and provides power to the internal control circuitry and internal regulator. Very high di/dt is seen at VIN during switch on and off transitions. High frequency decoupling capacitors mounted in close proximity to the input pin and case ground (see Figure 1) are recommended to minimize voltage spikes. VIN should be connected to a low impedance source for best operation.

FB - The FB (feedback) pin's primary function is to set the output voltage. Use a resistive divider from VOUT to GND to set the voltage at the feedback pin to 1.21V when the output voltage is at the desired level. The FB pin provides two additional functions. If the voltage at the FB pin drops below 0.8V the switch current limit is reduced. When the voltage at the FB pin drops below 0.7V the switching frequency is reduced. The switching frequency reduces to approximately 100KHz at $V_{FB} \leq 0.4V$.

CASE - The CASE GND provides a return path for all internal control current and acts as a reference to the error amplifier. It is important that it is at the same voltage potential as the load return to ensure proper regulation. Keep current on the ground between the load and the MSK5048RH to a minimum. Use heavy copper traces or a ground plane to minimize voltage drops and regulation error use the case ground connection to decouple the input as close to the VIN pin as possible (see Figure 1).

VOUT - VOUT is the output of the regulator. External capacitance between the VOUT pin and GND is required to maintain stability and minimize output ripple voltage, see "Selecting The Output Capacitor." Provide a low impedance path between VOUT and the load to minimize voltage drops.

COMP - The COMP pin is the output of the error amplifier and the input of the peak current comparator. This pin is typically used for frequency compensation but can also be used as a current clamp or as an override to the internal error amplifier control. The pin voltage is typically around 1V at light load and 2V at heavy load. Driving the pin low will shut down the regulator. Driving it high will increase the output current. The current into the COMP pin must be limited to 4mA when driving it high.

SYNC - The SYNC pin is used to synchronize the oscillator to an external clock. It is logic compatible and can be driven to any frequency between the free run frequency (500KHz nominal) and 1MHz. At frequencies greater than 700KHz the risk of sub harmonic oscillation increases for applications with duty cycles greater than 50%. This is the result of the magnitude of the slope compensation ramp generated by the control IC being limited at higher frequencies. The duty cycle of the input signal must be between 10% and 90% to ensure proper synchronization. Tie the SYNC pin to GND if it is not used.

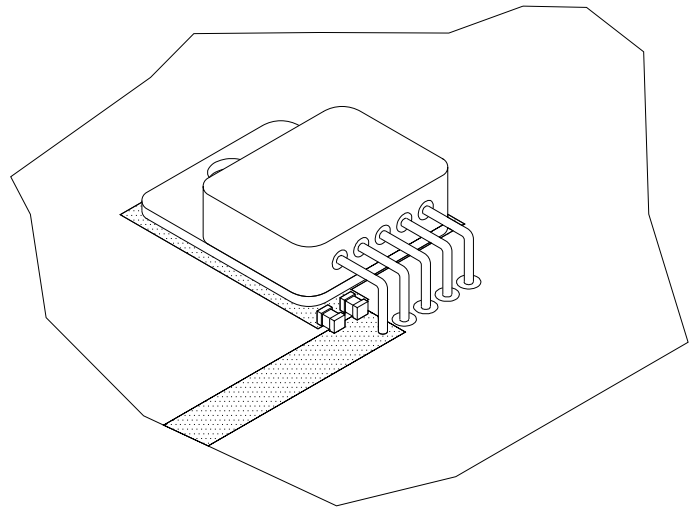

FIGURE 1

SETTING THE OUTPUT VOLTAGE

The output voltage of the MSK5048RH is set with a simple resistor divider network: see Figure 2 (Typical Application Circuit). Select the resistor values to divide the desired output down to equal VFB (1.21V nominal) at the FB pin. Use a 2.5K or lower value resistor for R2 to keep output error due to FB pin bias current less than 0.1%.

$$V_{OUT} = V_{FB} * (1 + R1/R2)$$

$$R1 = R2 * ((V_{OUT}/V_{FB}) - 1)$$

Given $V_{FB} = 1.21V$ Nominal

TOTAL DOSE RADIATION AND SEE TEST PERFORMANCE

Radiation performance curves for TID testing are generated for all radiation testing performed by TTM Technologies. These curves show performance trends throughout the TID test process and are located in the MSK5048RH radiation test report. The complete radiation test report is available in the RAD HARD PRODUCTS section on the TTM Technologies website. Contact TTM Technologies for SEE test results.

TYPICAL APPLICATION CIRCUIT

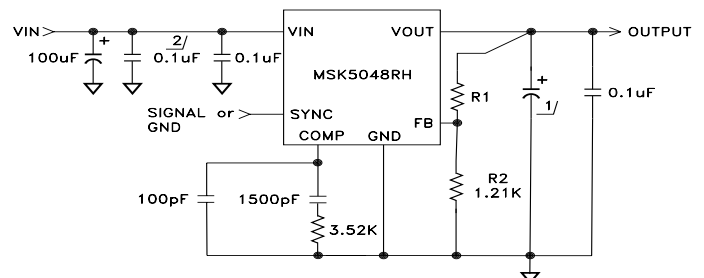

1/ AVX PART NUMBER TAZH227K010C(CWR29FC227KAHZ)

2/ CERAMIC INPUT CAPACITORS MUST BE PLACED AS CLOSE TO PIN1 AND THE CASE AS POSSIBLE (SEE FIGURE1).

FIGURE 2

SELECTING THE OUTPUT CAPACITOR

The output capacitor filters the ripple current from the internal inductor to an acceptable ripple voltage seen by the load. The primary factor in determining voltage ripple is the ESR of the output capacitor. The voltage ripple can be approximated as follows:

$$V_{P-P} = I_{P-P} * ESR$$

$$\text{Where } I_{P-P} = V_{OUT} * (V_{IN} - V_{OUT}) / (1.65 * V_{IN})$$

The typical ESR range for an MSK5048RH application is between 0.05 and 0.20 ohm. Capacitors within these ESR ranges typically have enough capacitance value to make the capacitive term of the ripple equation insignificant. The capacitive term of the output voltage ripple lags the ESR term by 90° and can be calculated as follows:

$$V_{P-P}(CAP) = I_{P-P} / (8 * F * C)$$

Where:

C = output capacitance in Farads

F = Switching Frequency in Hertz

Anaren-MSK Products has found through analysis that AVX brand TAZH227K010C (CWR29FC227KAHZ) typically have ESR values between 20 and 50mΩ. Worst Case Circuit Analysis has demonstrated EOL stability with that capacitor screened for ESR less than 50mΩ in the typical application circuit.

Select a capacitor or combination of capacitors that can tolerate the worst-case ripple current with sufficient de-rating. When using multiple capacitors in parallel to achieve ESR and/or total capacitance, sharing of ripple current between capacitors will be approximately equal if all of the capacitors are the same type and preferably from the same lot. Low ESR tantalum capacitors are recommended over aluminum electrolytic. The zero created by the ESR of the capacitor is necessary for loop stability. A small amount of ceramic capacitance close to the load to decouple high frequency is acceptable but it should not cancel the ESR zero.

TYPICAL PERFORMANCE CURVES

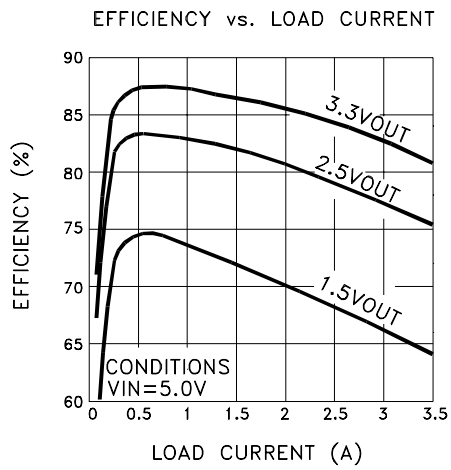
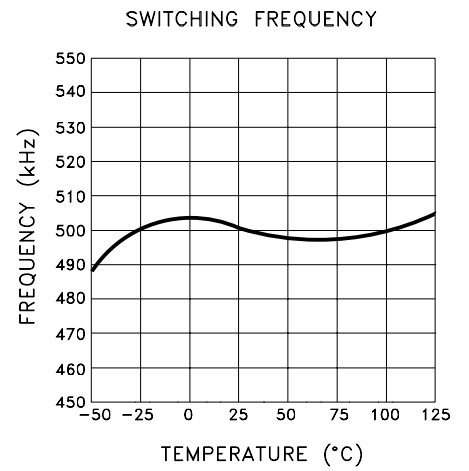
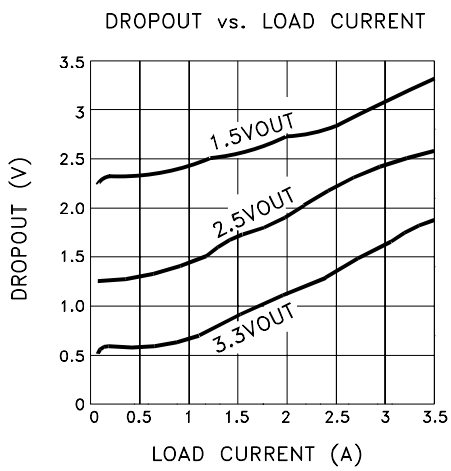
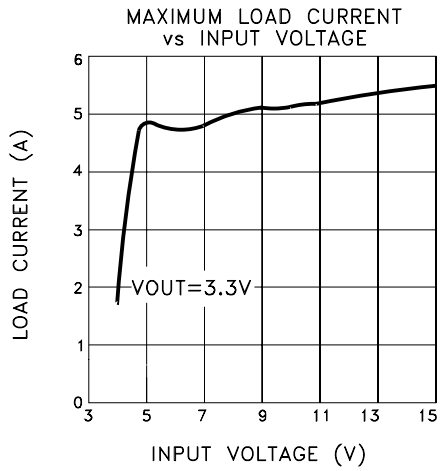
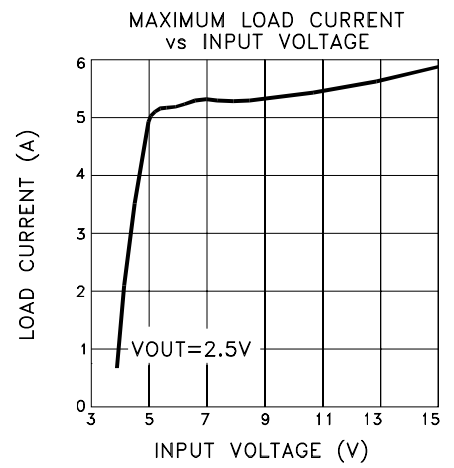
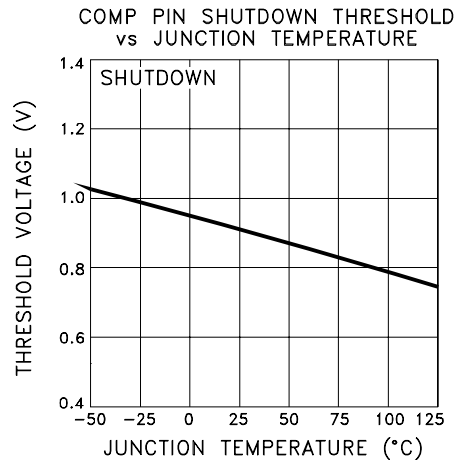
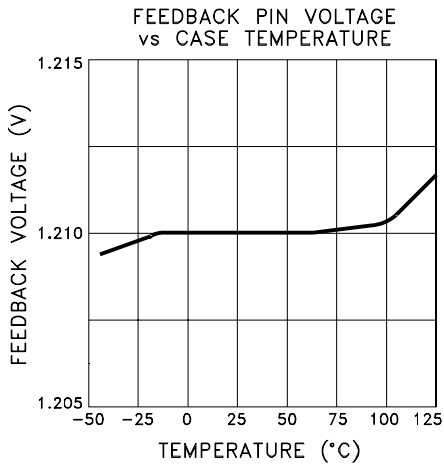

TYPICAL PERFORMANCE CURVES CONT'D

GAIN AND PHASE RESPONSE

The gain and phase response curves are for the MSK typical application circuit and are representative of typical device performance, but are for reference only. The performance should be analyzed for each application to insure individual program requirements are met. External factors such as temperature, input and output voltages, capacitors, etc. all can be major contributors. Please consult factory for additional details.

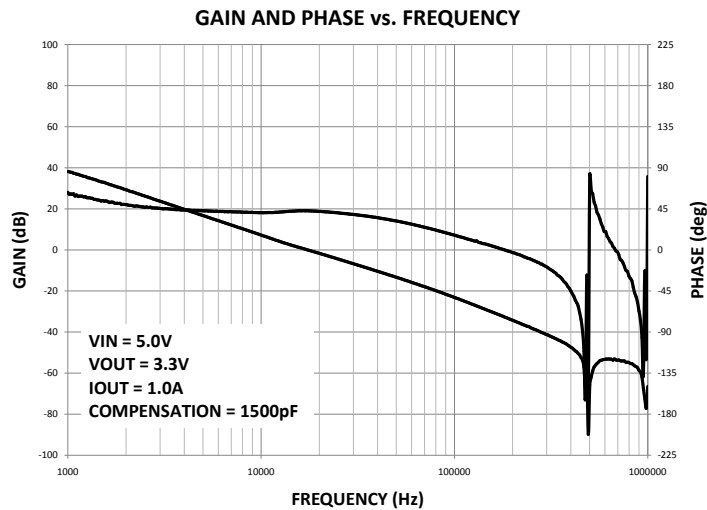
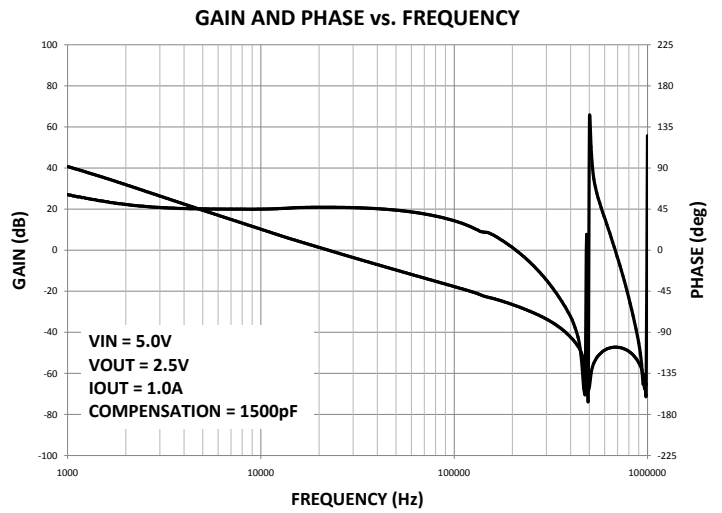
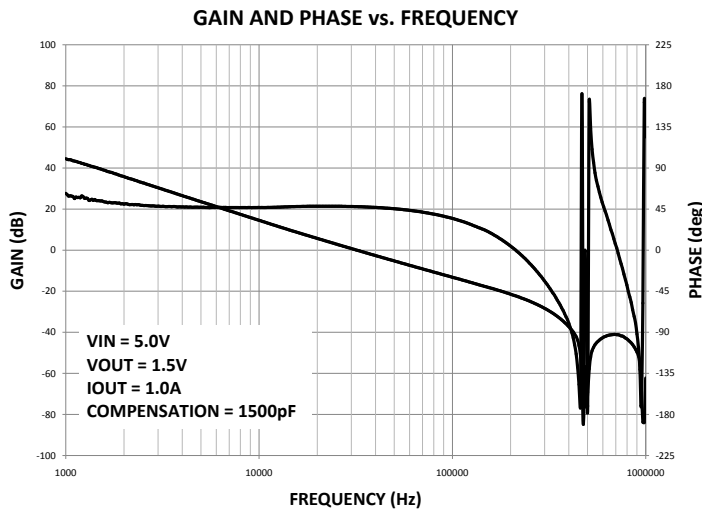

MECHANICAL SPECIFICATIONS

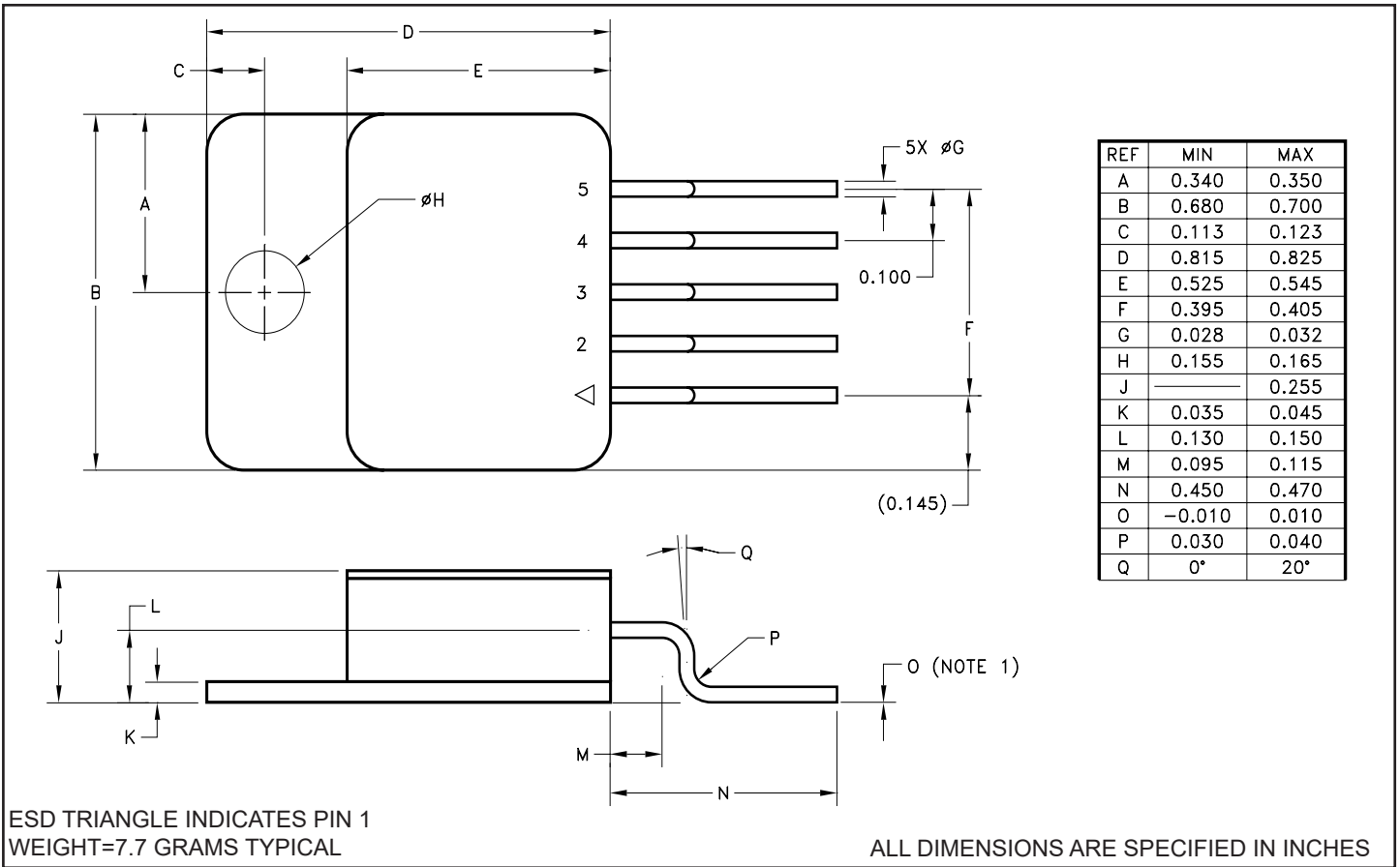

ORDERING INFORMATION

MSK5048 K RH GW

LEAD CONFIGURATIONS

GW= GULL WING

RADIATION HARDENED

SCREENING

BLANK= INDUSTRIAL; H=MIL-PRF-38534 CLASS H;

K=MIL-PRF-38534 CLASS K

GENERAL PART NUMBER

The above example is a Class K switching regulator with gull wing leads.

NOTE: See DLA SMD 5962R11232 for DLA part number options.

MECHANICAL SPECIFICATIONS

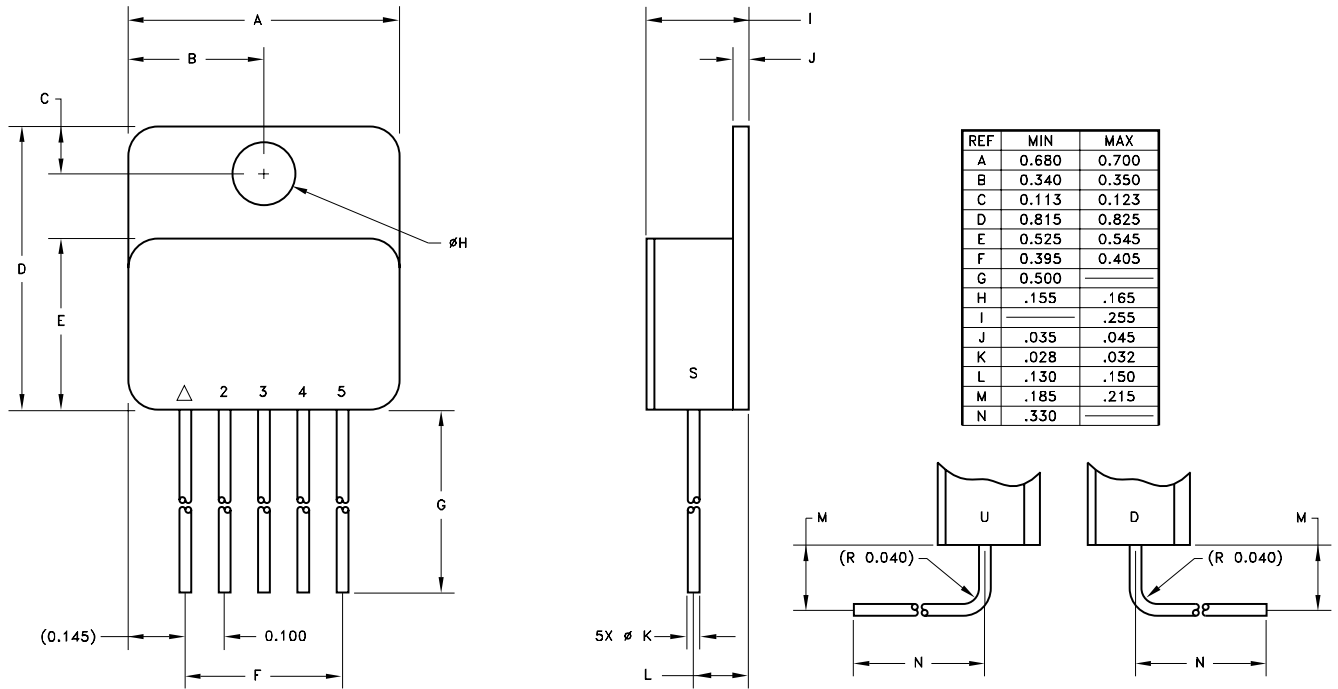

ESD TRIANGLE INDICATES PIN 1
WEIGHT=7.87 GRAMS TYPICAL

ALL DIMENSIONS ARE SPECIFIED IN INCHES

ORDERING INFORMATION

MSK5048 K RH U

LEAD CONFIGURATIONS

S= STRAIGHT; U= BENT DOWN; D=BENT DOWN

RADIATION HARDENED

SCREENING

BLANK= INDUSTRIAL; H=MIL-PRF-38534 CLASS H;

K=MIL-PRF-38534 CLASS K

GENERAL PART NUMBER

The above example is a Class K switching regulator with leads bent up.

NOTE: See DLA SMD 5962R11232 for DLA part number options.

REVISION HISTORY

REV	STATUS	DATE	DESCRIPTION
H	Released	08/14	Update SMD status, correct typos, update format.
J	Released	12/14	Correct adjustable output voltage typo in features list.
K	Released	12/14	add ESD rating and update format.
L	Released	02/15	Clarify maximum current rating.
M	Released	06/17	Change typical application circuit and add recommended capacitor in test.
N	Released	03/22	Remove MIL-PRF-38535, update company name and website.

TTM Technologies
www.ttmtech.com

The information contained herein is believed to be accurate at the time of printing. TTM Technologies reserves the right to make changes to its products or specifications without notice, however and assumes no liability for the use of its products. Please visit our website for the most recent revision of this data sheet.