



**VERY HIGH CURRENT,
LOW DROPOUT
VOLTAGE REGULATORS**

**5176
SERIES**

FEATURES:

- Electrically Isolated Top Tab or Z Tab SIP
- Extremely Low Dropout Voltage: 425mV @ 7.5 Amps
- Available in +1.5V, +1.7V, +1.9V, +2.5V, +3.3V, +5.0V and +12.0V
- TTL Level Enable Pin: Zero Current Shutdown Mode
- Reverse Battery and Load Dump Protection
- Low Ground Current: 130mA Typical at Full Load
- 1% Maximum Guaranteed Accuracy
- Output Current to 7.5 Amps

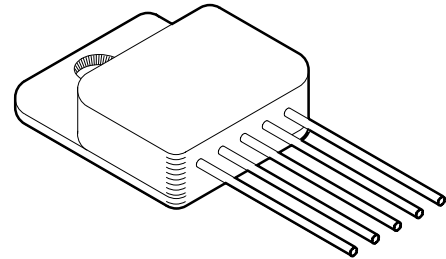

DESCRIPTION:

The MSK5176 series voltage regulators are available in +1.5V, +1.7V, +1.9V, +2.5V, +3.3V, +5.0V and +12.0V configurations. All boast ultra low dropout specifications due to the utilization of a super PNP output pass transistor with monolithic technology. Dropout voltages of 425mV at 7.5 amps are typical in this configuration, which drives efficiency up and power dissipation down. Accuracy is guaranteed with a 1% maximum output voltage tolerance. The series also offers a TTL/CMOS compatible on/off enable function. The MSK5176 series is packaged in a space efficient 5 pin power SIP available in two styles with three lead bend options.

EQUIVALENT SCHEMATIC

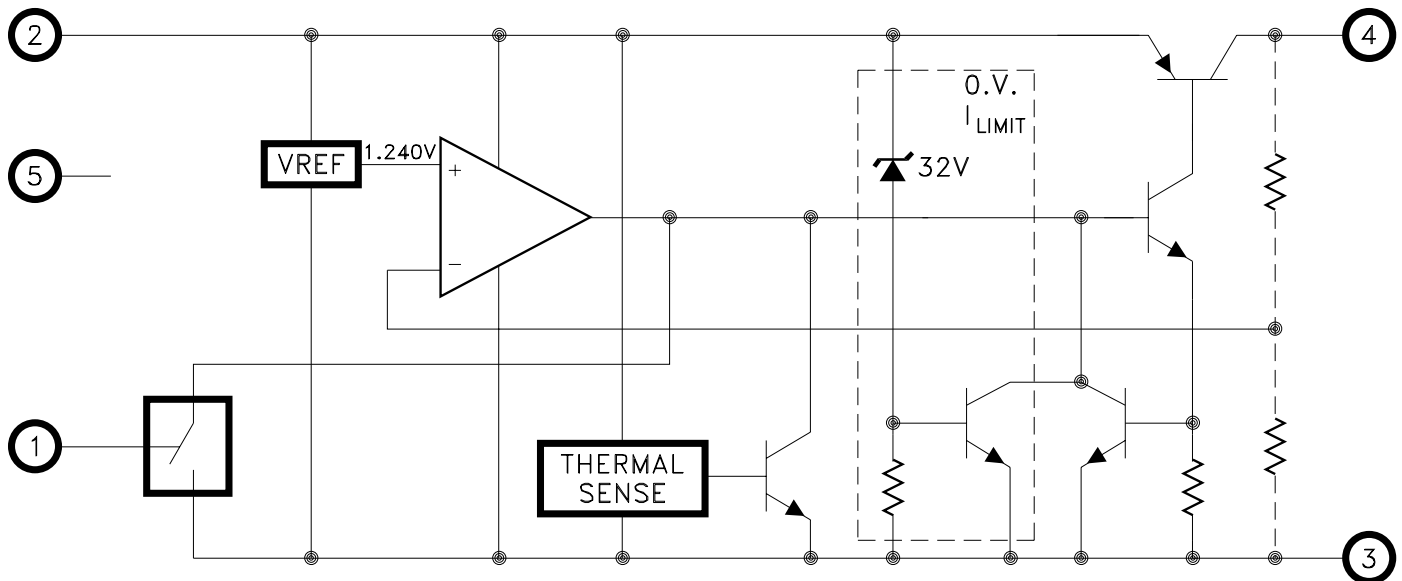

TYPICAL APPLICATIONS

- High Efficiency, Ultra High Current Linear Regulators
- Constant Voltage/Current Regulators
- System Power Supplies
- Switching Power Supply Post Regulators
- Battery Powered Equipment

PIN-OUT INFORMATION

- 1 ENABLE
- 2 VIN
- 3 GROUND
- 4 VOUT
- 5 NC

CASE = ISOLATED

ABSOLUTE MAXIMUM RATINGS

⑩

V _{INP} Input Voltage (100mS 1% D.C.)	-20V to +60V
V _{IN} Input Voltage	26V
V _{EN} Enable Voltage	-0.3V to 26V
I _{OUT} Output Current	7.5A

T _{ST} Storage Temperature Range	⑪	-65°C to +150°C
T _{LD} Lead Temperature (10 Seconds Soldering)		300°C
T _C Case Operating Temperature Range		
MSK5176 Series		-40°C to +85°C
MSK5176H Series		-55°C to +125°C

ELECTRICAL SPECIFICATIONS

Parameter	Test Conditions ① ③	Group A Subgroup	MSK5176H SERIES			MSK5176 SERIES			Units
			Min.	Typ.	Max.	Min.	Typ.	Max.	
Output Voltage Tolerance	I _{OUT} = 10mA; V _{IN} = V _{OUT} +1V	1	-	±0.5	±1.0	-	±0.5	±1.0	%
		2, 3	-	±1.0	±2.0	-	-	-	%
Dropout Voltage	② ΔV _{OUT} = -1%; I _{OUT} = 250mA	1	-	80	200	-	80	225	mV
	② ΔV _{OUT} = -1%; I _{OUT} = 7.5A	1	-	425	600	-	425	625	mV
Load Regulation ⑧	V _{IN} = V _{OUT} +1.5V 10mA ≤ I _{OUT} ≤ 7A	1	-	±0.2	±1.0	-	±0.2	±1.2	%
		2, 3	-	±0.3	±2.0	-	±0.3	-	%
Line Regulation	(V _{OUT} +1V) ≤ V _{IN} ≤ 26V I _{OUT} = 10mA	1	-	±0.05	±0.5	-	±0.05	±0.6	%
		2, 3	-	±0.5	±1.0	-	±0.5	-	%
Output Current Limit ② ⑨	V _{OUT} = 0V; V _{IN} = V _{OUT} +1V	-	-	9.5	15	-	9.5	15	A
Ground Current ②	V _{IN} = V _{OUT} +1V; I _{OUT} = 4A	-	-	45	85	-	45	90	mA
	V _{IN} = V _{OUT} +1V; I _{OUT} = 7.5A	-	-	130	-	-	130	-	mA
Output Noise ②	C _L = 33μF; 10Hz ≤ f ≤ 100KHz	-	-	260	-	-	260	-	μV
Enable Input Voltage ②	HIGH/ON	1	2.4	1.2	-	2.4	1.2	-	V
	LOW/OFF	1	-	1.2	0.8	-	1.2	0.8	V
Enable Input Current ②	HIGH/ON	1	-	100	600	-	100	600	μA
	LOW/OFF	1	-	-	2	-	-	2	μA
Shutdown Output Current ②	V _{ENABLE} ≤ 0.8V	-	-	10	500	-	10	500	μA
Thermal Resistance ②	Junction to Case @ 125°C	-	-	0.9	1.3	-	0.9	1.5	°C/W
Thermal Shutdown ②	T _J	-	-	135	-	-	135	-	°C

NOTES:

- ① Output decoupled to ground using 33μF minimum capacitance unless otherwise specified.
- ② This parameter is guaranteed by design but need not be tested.
Typical parameters are representative of actual device performance but are for reference only.
- ③ All output parameters are tested using a low duty cycle pulse to maintain T_J = T_C.
- ④ Industrial grade devices shall be tested to subgroup 1 unless otherwise specified.
- ⑤ Military grade devices ("H" suffix) shall be 100% tested to subgroups 1, 2 and 3.
- ⑥ Subgroup 1 T_C = +25°C
Subgroup 2 T_C = +125°C
Subgroup 3 T_C = -55°C
- ⑦ Please consult the factory if alternate output voltages are required.
- ⑧ Due to current limit, maximum output current may not be available at all values of V_{IN} - V_{OUT} and temperatures. See typical performance curves for clarification.
- ⑨ The output current limit function provides protection from transient overloads but it may exceed the maximum continuous rating. Continuous operation in current limit may damage the device.
- ⑩ Continuous operation at or above absolute maximum ratings may adversely effect the device performance and/or life cycle.
- ⑪ Internal solder reflow temperature is 180°C, do not exceed.

APPLICATION NOTES

REGULATOR PROTECTION

The MSK5176 series is fully protected against reversed input polarity, overcurrent faults, overtemperature conditions (P_D) and transient voltage spikes of up to 60V. If the regulator is used in dual supply systems where the load is returned to a negative supply, the output voltage must be diode clamped to ground.

OUTPUT CAPACITOR

The output voltage ripple of the MSK5176 series voltage regulators can be minimized by placing a filter capacitor from the output to ground. The optimum value for this capacitor may vary from one application to the next, but a minimum of 33 μ F is recommended for optimum performance. This capacitor need not be an expensive low ESR type: aluminum electrolytics are adequate. In fact, extremely low ESR capacitors may contribute to instability. Tantalum capacitors are recommended for systems where fast load transient response is important. Transient load response can also be improved by placing a capacitor directly across the load.

LOAD CONNECTIONS

In voltage regulator applications where very large load currents are present, the load connection is very important. The path connecting the output of the regulator to the load must be extremely low impedance to avoid affecting the load regulation specifications. Any impedance in this path will form a voltage divider with the load.

ENABLE PIN

The MSK5176 series of voltage regulators are equipped with a TTL compatible ENABLE pin. A TTL high level on this pin activates the internal bias circuit and powers up the device. A TTL low level on this pin places the controller in shutdown mode and the device draws approximately 10 μ A of quiescent current. If the enable function is not used, simply connect the enable pin to the input.

DEVICE/CASE CONNECTION

The MSK5176 series are highly thermally conductive devices and the thermal path from the package heat sink to the internal junctions is very short. Since the case is electrically isolated from the internal circuitry, the package can be directly connected to a heat sink.

HEAT SINK SELECTION

To select a heat sink for the MSK5176, the following formula for convective heat flow may be used.

Governing Equation:

$$T_J = P_D \times (R_{\theta JC} + R_{\theta CS} + R_{\theta SA}) + T_A$$

Where:

T_J = Junction Temperature

P_D = Total Power Dissipation

$R_{\theta JC}$ = Junction to Case Thermal Resistance

$R_{\theta CS}$ = Case to Heat Sink Thermal Resistance

$R_{\theta SA}$ = Heat Sink to Ambient Thermal Resistance

T_A = Ambient Temperature

First, the power dissipation must be calculated as follows:

$$\text{Power Dissipation} = (V_{IN} - V_{OUT}) \times I_{OUT}$$

Next, the user must select a maximum junction temperature. The absolute maximum allowable junction temperature is 125°C. The equation may now be rearranged to solve for the required heat sink to ambient thermal resistance ($R_{\theta SA}$).

Example:

An MSK5176-3.3 is configured for $V_{IN} = +5V$ and $V_{OUT} = +3.3V$. I_{OUT} is a continuous 1A DC level. The ambient temperature is +25°C. The maximum desired junction temperature is 125°C.

$R_{\theta JC} = 1.3^\circ\text{C/W}$ and $R_{\theta CS} = 0.15^\circ\text{C/W}$ for most thermal greases

$$\begin{aligned} \text{Power Dissipation} &= (5V - 3.3V) \times (1A) \\ &= 1.7 \text{ Watts} \end{aligned}$$

Solve for $R_{\theta SA}$:

$$\begin{aligned} R_{\theta SA} &= \left[\frac{125^\circ\text{C} - 25^\circ\text{C}}{1.7\text{W}} \right] - 1.3^\circ\text{C/W} - 0.15^\circ\text{C/W} \\ &= 57.37^\circ\text{C/W} \end{aligned}$$

In this example, a heat sink with a thermal resistance of no more than 57°C/W must be used to maintain a junction temperature of no more than 125°C.

TYPICAL PERFORMANCE CURVES

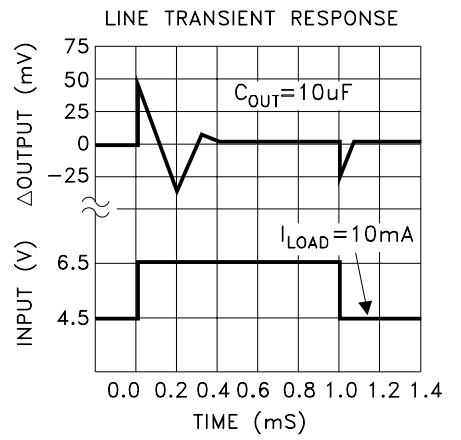
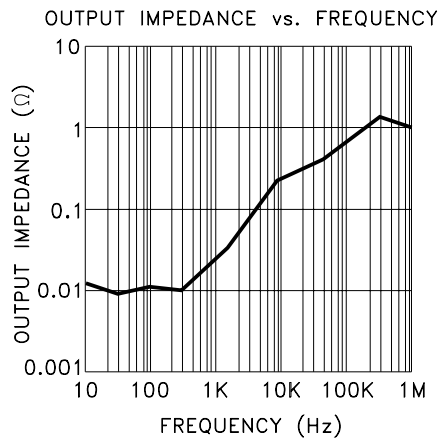
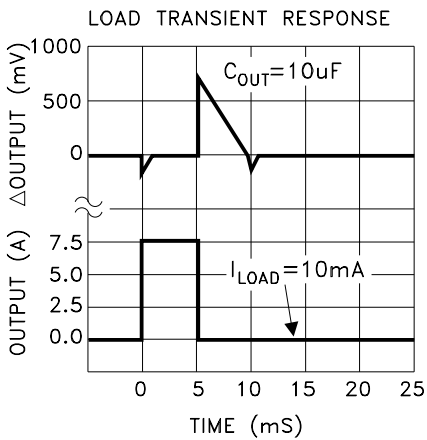
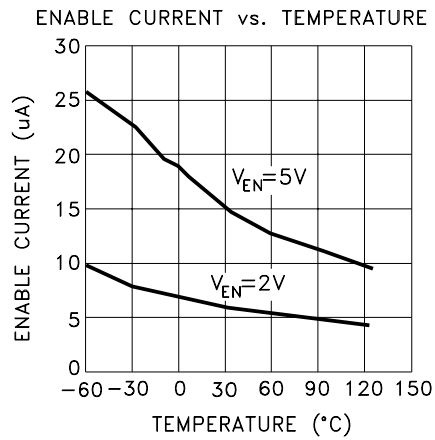
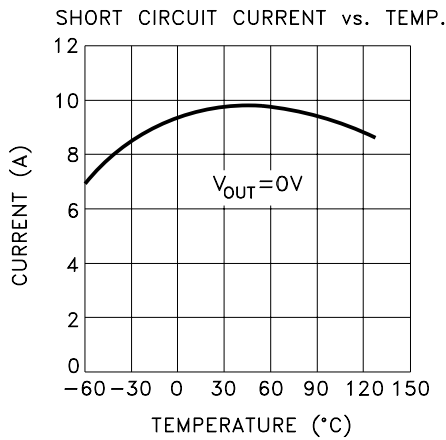
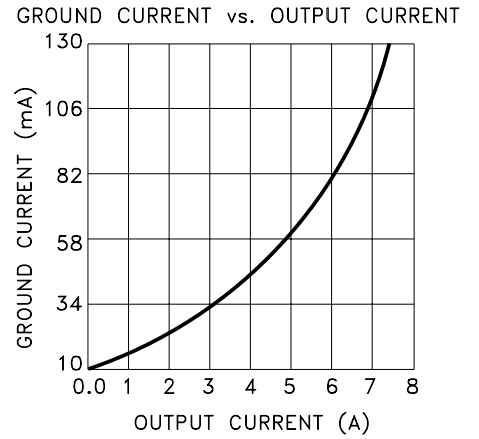
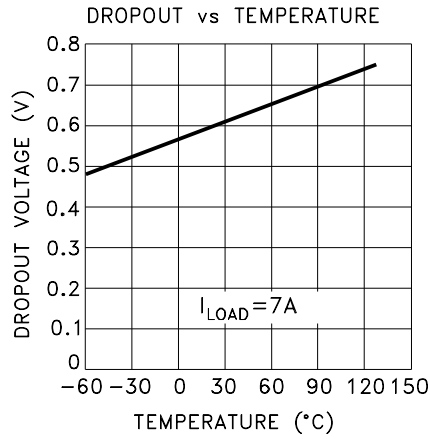
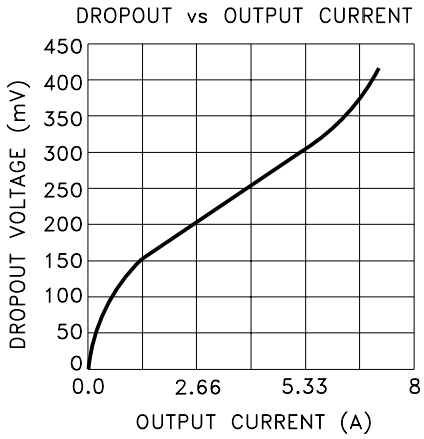

MECHANICAL SPECIFICATIONS

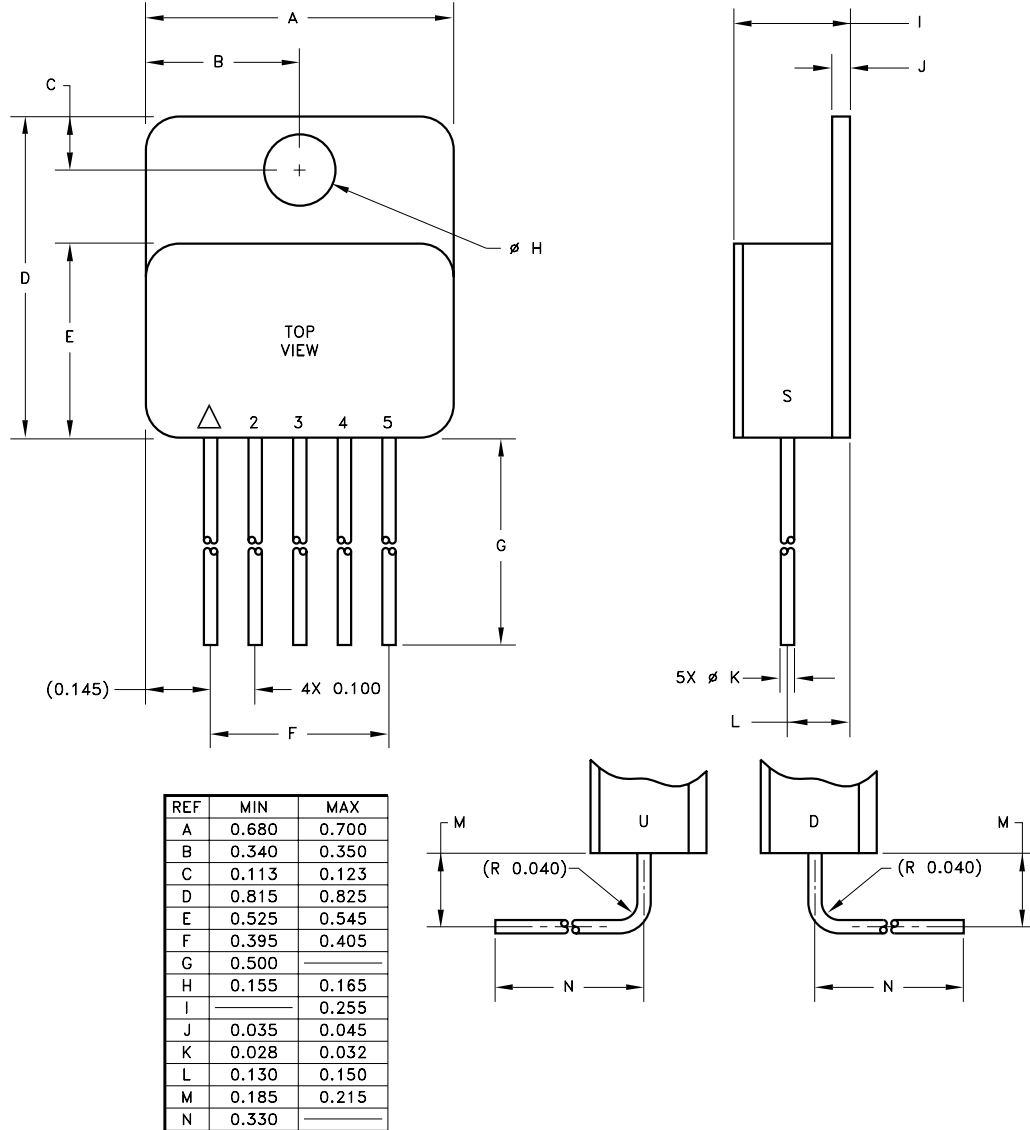

ESD TRIANGLE INDICATES PIN 1
WEIGHT = 7.7 GRAMS TYPICAL

ALL DIMENSIONS ARE SPECIFIED IN INCHES

ORDERING INFORMATION

MSK5176-3.3 H T U

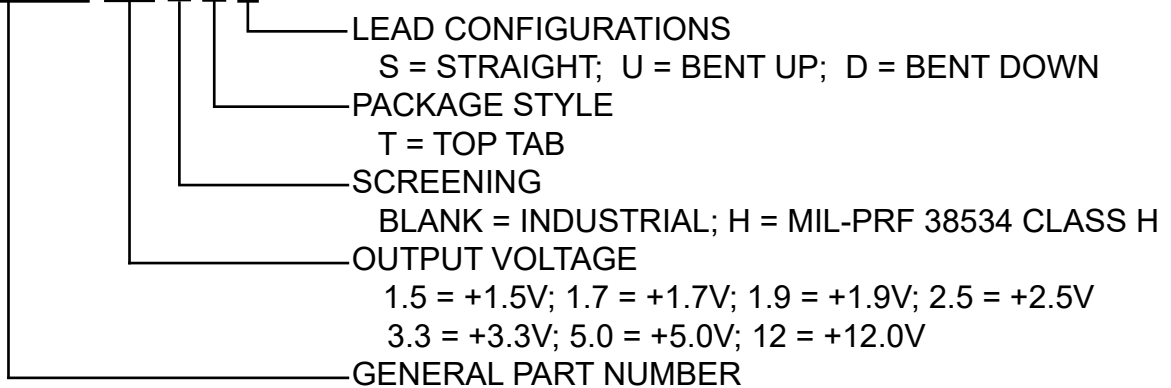

The above example is a +3.3V, Military regulator using the top tab package with leads bent up.

MECHANICAL SPECIFICATIONS CONT'D

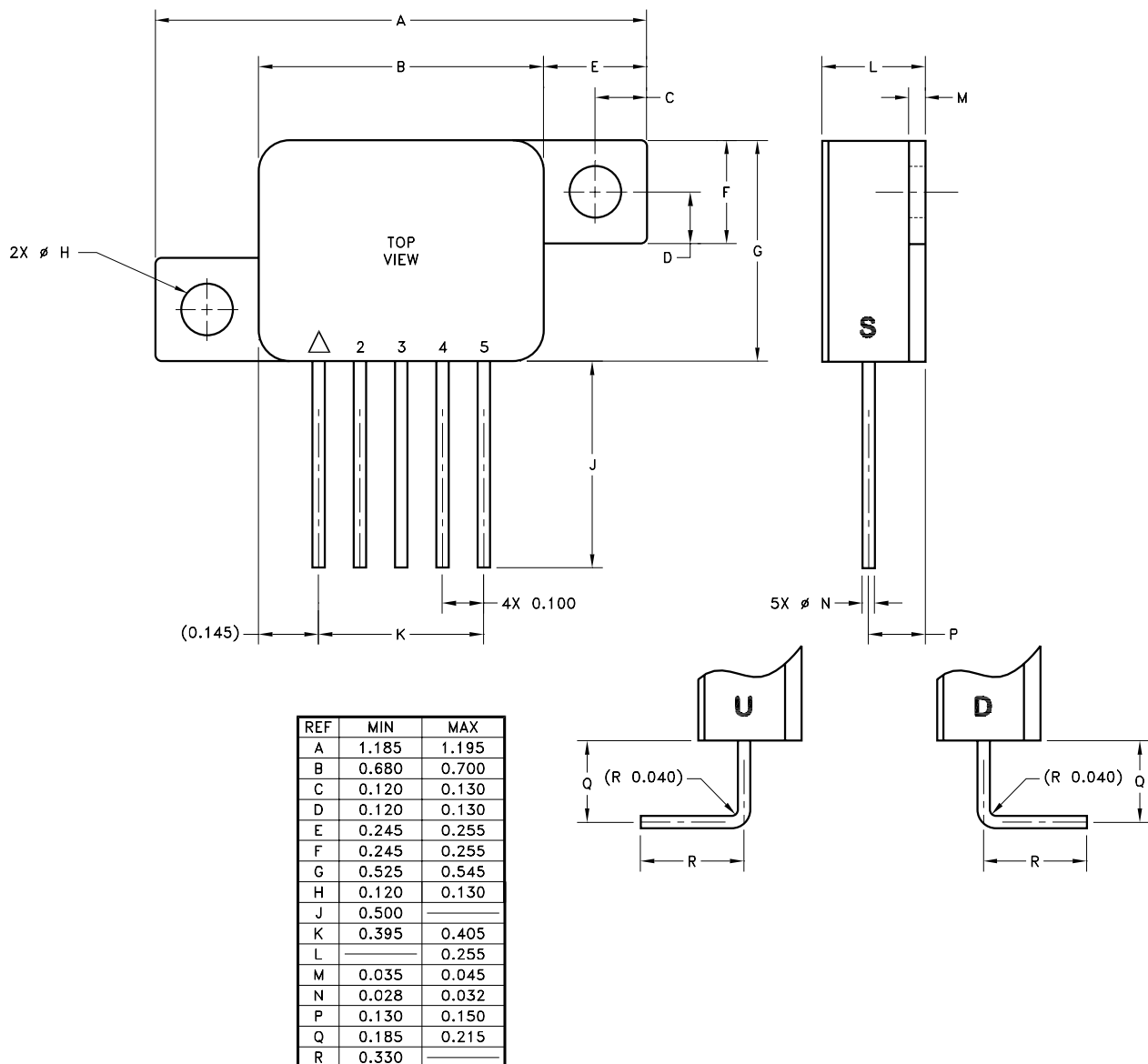

ESD TRIANGLE INDICATES PIN 1
 WEIGHT = 8.1 GRAMS TYPICAL

ALL DIMENSIONS ARE SPECIFIED IN INCHES

ORDERING INFORMATION

MSK5176-3.3 H Z U

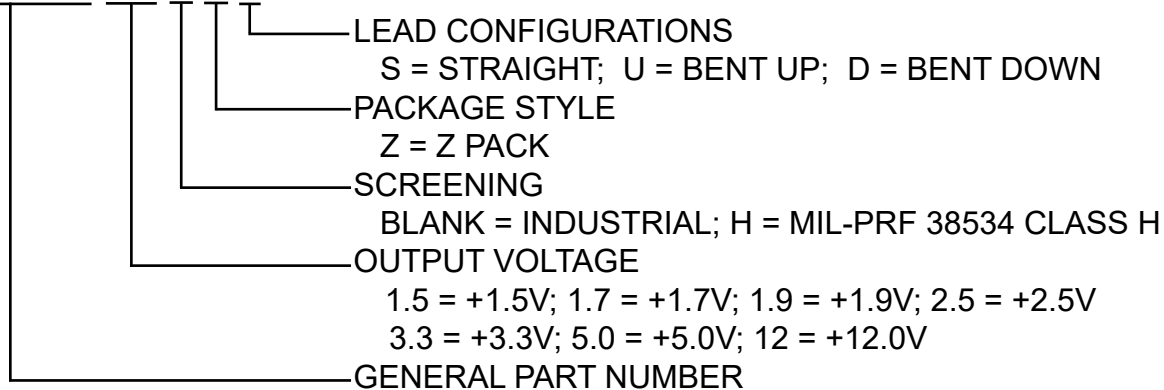

REVISION HISTORY

REV	STATUS	DATE	DESCRIPTION
D	Released	02/16	Add internal note and clarify mechanical specifications
E	Released	04/23	Remove MIL-PRF-38535 and update company name and website

TTM Technologies

www.ttm.com

The information contained herein is believed to be accurate at the time of printing. TTM Technologies reserves the right to make changes to its products or specifications without notice, however and assumes no liability for the use of its products. Please visit our website for the most recent revision of this data sheet.