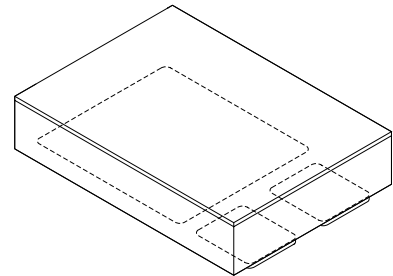
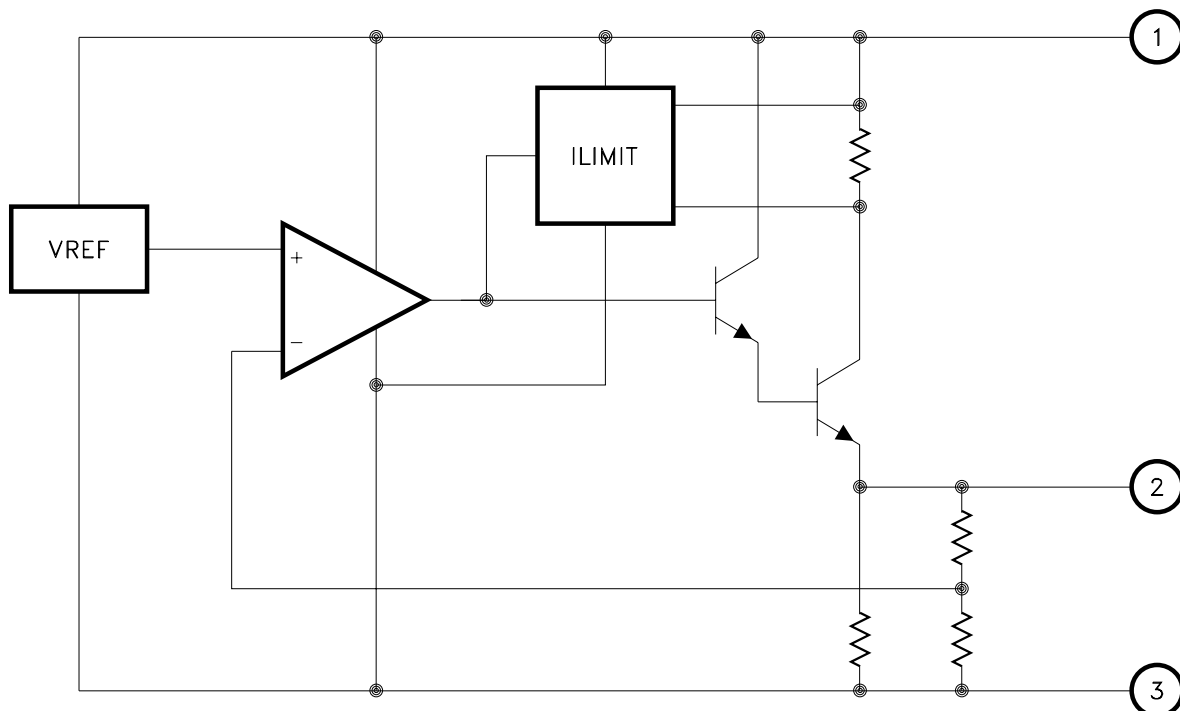

FEATURES:

- Ultra-Fast Transient Response
- Very Low Output Voltage
- Available in 0.8V, 0.9V, 1.0V, 1.2V, 1.3V, 1.4V and 1.5V
- On Board Thermal Shut Down
- Reverse Battery and Load Dump Protection
- 1% Maximum Guaranteed Accuracy
- Output Current to 5 Amps
- Alternate Output Voltages Available
- Ultra-Low Package Height - 0.110" Max.
- Contact TTM Technologies for MIL-PRF-38534 Qualification Status

**DESCRIPTION:**

The MSK5251 series voltage regulators offer high current and low output voltage capability ideal for use with low voltage microprocessors. Low output impedance, very fast transient response and minimal output capacitance requirements make the MSK5251 an excellent choice for ASIC and FPGA core voltage supplies. The device is available in +0.8V, +0.9V, +1.0V, +1.2V, +1.3V, +1.4V and +1.5V output configurations with output accuracy guaranteed to 1% maximum. The MSK5251 series is packaged in a low profile 3 pin hermetically sealed power surface mount ceramic package.

EQUIVALENT SCHEMATIC**TYPICAL APPLICATIONS**

- PLD/FPGA Core Power Supply
- ASIC Core Voltage Regulator
- System Power Supplies
- Switching Power Supply Post Regulators
- Battery Powered Equipment

PIN-OUT INFORMATION

- | | |
|---|--------|
| 1 | VIN |
| 2 | VOUT |
| 3 | GROUND |

ABSOLUTE MAXIMUM RATINGS

⑨

VIN Input Voltage.....+6.5V
 PD Power Dissipation..... Internally Limited

TST Storage Temperature Range-65°C to +150°C
 TLD Lead Temperature
 (10 Seconds Soldering).....300°C
 Tc Case Operating Temperature Range
 MSK5251 Series.....-40°C to +85°C
 MSK5251H Series-55°C to +125°C

ELECTRICAL SPECIFICATIONS

Parameter	Test Conditions ① ③	Group A Subgroup	MSK5251H SERIES			MSK5251 SERIES			Units
			Min.	Typ.	Max.	Min.	Typ.	Max.	
Input Voltage Range	VOUT ≤ 1V	-	+3.0	-	±6.5	+3.0	-	±6.5	%
	VOUT ≥ 1V	-	VOUT +2.1	-	±6.5	VOUT +2.1	-	±6.5	%
Quiescent Current ②	IL = 0mA	1	-	48	60	-	48	70	mA
	IL = 5.0A	1	-	70	120	-	70	130	mA
Output Voltage Tolerance	VIN = 5V; IOUT = 10mA	1	-	±0.5	±1.0	-	±0.5	±1.2	%
		2B, 3	-	±1.0	±2.5	-	-	-	%
Dropout Voltage ②	ΔVOUT = -1%; IOUT = 2.5mA	1	-	1.5	2.0	-	1.5	2.0	V
	ΔVOUT = -1%; IOUT = 5mA	1	-	1.7	2.1	-	1.7	2.1	V
Load Regulation ⑧	10mA ≤ IOUT ≤ 5.0A	1	-	±0.2	±1.0	-	±0.2	±1.2	%
		2, 3	-	±0.3	±2.0	-	±0.3	-	%
Line Regulation	VIN Min to +6V IOUT = 10mA	1	-	±0.05	±0.5	-	±0.05	±0.6	%
		2, 3	-	±0.5	±1.0	-	±0.5	-	%
Output Current Limit ② ⑧	VOUT = 0V	-	-	7.5	9.5	-	7.5	9.5	A
Thermal Resistance ②	Junction to Case @ 125°C	-	-	1.6	2.0	-	1.6	2.2	°C/W
Thermal Shutdown	TJ	-	-	140	-	-	140	-	°C
Turn On Time ②	COUT = 10μF	4	-	10	45	-	10	55	μS

PART NUMBER	OUTPUT VOLTAGE ⑦
MSK5251-0.8	+0.8V
MSK5251-0.9	+0.9V
MSK5251-1.0	+1.0V
MSK5251-1.2	+1.2V
MSK5251-1.3	+1.3V
MSK5251-1.4	+1.4V
MSK5251-1.5	+1.5V

NOTES:

- ① Output decoupled to ground using 10μF ceramic capacitor unless otherwise specified.
- ② This parameter is guaranteed by design but need not be tested. Typical parameters are representative of actual device performance but are for reference only.
- ③ All output parameters are tested using a low duty cycle pulse to maintain TJ = Tc.
- ④ Industrial grade devices shall be tested to subgroup 1 unless otherwise specified.
- ⑤ Military grade devices ("H" suffix) shall be 100% tested to subgroups 1, 2 and 3.
- ⑥ Subgroup 1 Tc = +25°C
 Subgroup 2 TJ = +125°C
 Subgroup 2B Tc = +135°C
 Subgroup 3 TA = -55°C
- ⑦ Please consult the factory if alternate output voltages are required.
- ⑧ Due to internal thermal shutdown, maximum output current may not be available at all values of VIN - VOUT and temperatures. See typical performance curves for clarification.
- ⑨ Continuous operation at or above absolute maximum ratings may adversely effect the device performance and/or life cycle.

APPLICATION NOTES

REGULATOR PROTECTION

The MSK5251 series are high performance linear regulators for high current, low voltage applications requiring fast transient response. The devices are fully protected from damage due to fault conditions, offering constant current limiting and thermal shutdown. The thermal shutdown junction temperature is typically 140°C and is 100% tested to verify thermal shutdown occurs above 135°C.

INPUT SUPPLY VOLTAGE

The input voltage must be maintained at a minimum of 3.0 volts for proper operation for devices with output voltage below 1.0 volt. With an output voltage of 1.0 volt or higher, the input voltage must be a minimum of 2.1 volts above the output.

LOAD CONNECTIONS

In voltage regulator applications where very large load currents are present, the load connection is very important. The path connecting the output of the regulator to the load must be extremely low impedance to avoid affecting the load regulation specifications. Any impedance in this path will form a voltage divider with the load.

MINIMIZING POWER DISSIPATION

To maximize the performance and reduce power dissipation of the MSK5251 series devices, V_{in} should be maintained as close to dropout as possible. See Input Supply Voltage requirements. A series resistor can be used to lower V_{in} close to the dropout specification, lowering the input to output voltage differential. In turn, this will decrease the power that the device is required to dissipate. Knowing peak current requirements and worst case voltages, a resistor can be selected that will drop a portion of the excess voltage and help to distribute the heating. The circuit below illustrates this method.

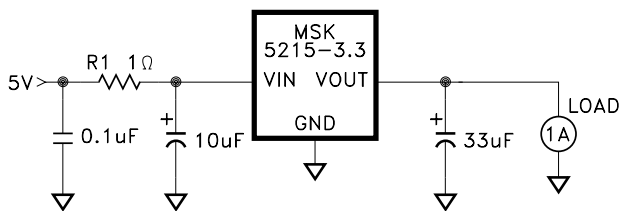

The maximum resistor value can be calculated from the following:

$$R1 \text{ max} = \frac{V_{IN \text{ min}} - (V_{OUT \text{ max}} + V_{DROP})}{I_{OUT \text{ peak}} + \text{Quiescent Current}}$$

Where: $V_{IN \text{ min}}$ = Minimum input voltage
 $V_{OUT \text{ max}}$ = Maximum output voltage across the full temperature range
 V_{DROP} = Worst case dropout voltage (Typically 2.1 Volts)
 $I_{OUT \text{ peak}}$ = Maximum load current
 Quiescent Current = Max. quiescent current at $I_{OUT \text{ peak}}$

INPUT CAPACITOR

If the device is to be located more than 4 inches from the bulk supply capacitance, a minimum 1µF capacitor should be placed as close to the input pin as possible for proper bypassing. A smaller value capacitor such as 0.01µF should be placed in parallel with the larger value capacitor. Larger input capacitor values will help to improve ripple rejection.

OUTPUT CAPACITOR

The MSK5251 series devices require a minimum of external components to maintain stability. A minimum of output capacitance is necessary for stable operation. Due to the wide bandwidth design, the device will operate with a wide range of capacitance and ESR values. For most applications, a 10µF ceramic capacitor will suffice. Ideally, this should be an X7R ceramic capacitor or a tantalum capacitor due to their thermal performance. There is no upper limit to the amount of output capacitance that may be used.

THERMAL SHUTDOWN

The MSK5251 series of devices is equipped with a thermal shutdown circuit that will turn off the device when the junction temperature reaches approximately 140°C. It is important for the user to be aware that high temperature operation will limit the current capability of the device due to this thermal shutdown protection. In cases of maximum input voltage and high case temperature, the output current available may be less than 3 Amps. See curve below for clarification.

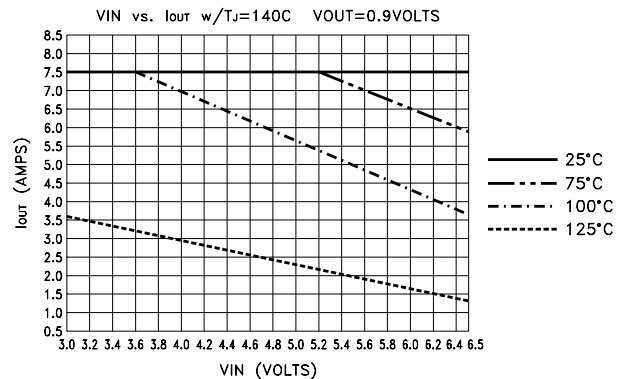

HEAT SINK SELECTION

To select a heat sink for the MSK5251, the following formula for convective heat flow may be used.

First, the power dissipation must be calculated as follows:

$$\text{Power Dissipation} = (V_{IN} - V_{OUT}) \times I_{OUT} \times \text{Quiescent Current}$$

Next, the user must select a maximum junction temperature. The equation may now be arranged to solve for the required heat sink to ambient thermal resistance ($R_{\theta SA}$).

Example:

An MSK5251-1.3 is configured for $V_{IN}=+3.4V$ and $V_{OUT}=+1.3V$. I_{OUT} is a continuous 5Amp DC level. Under these conditions the maximum quiescent current would be 120mA. The ambient temperature is +25°C and the maximum junction temperature is 125°C.

$$\begin{aligned} R_{\theta JC} &= 2.0^{\circ}\text{C/W} \text{ and } R_{\theta CS} = 0.5^{\circ}\text{C/W} \text{ typically.} \\ \text{Power Dissipation} &= (3.4V - 1.3V) \times (5A) + (3.4 \times 120\text{mA}) \\ &= 10.9 \text{ Watts} \end{aligned}$$

Solve for $R_{\theta SA}$:

$$\begin{aligned} R_{\theta SA} &= \left[\frac{125^{\circ}\text{C} - 25^{\circ}\text{C}}{10.9\text{W}} \right] - 2.0^{\circ}\text{C/W} - 0.5^{\circ}\text{C/W} \\ &= 6.67^{\circ}\text{C/W} \end{aligned}$$

In this example, a heat sink with a thermal resistance of no more than 6.6°C/W must be used to maintain a junction temperature of no more than 125°C.

TYPICAL PERFORMANCE CURVES

QUIESCENT CURRENT vs OUTPUT CURRENT

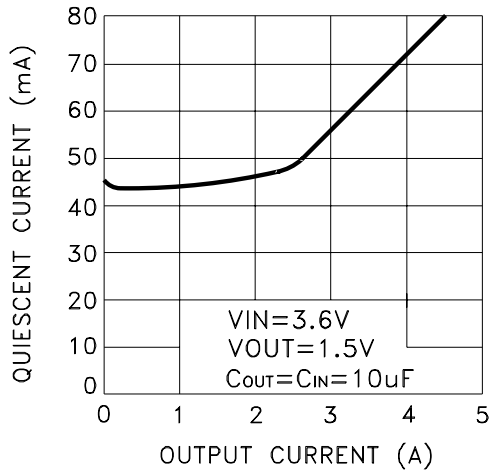

OUTPUT VOLTAGE vs TEMPERATURE

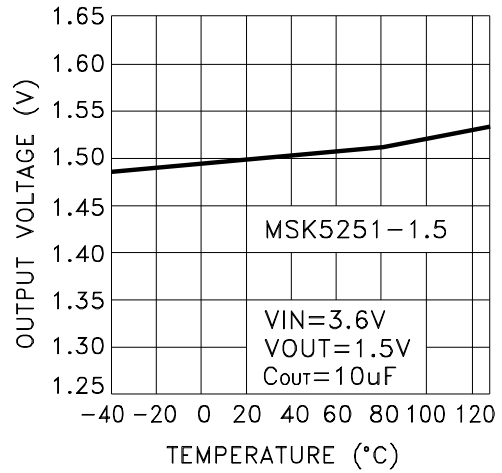

CURRENT LIMIT vs INPUT VOLTAGE

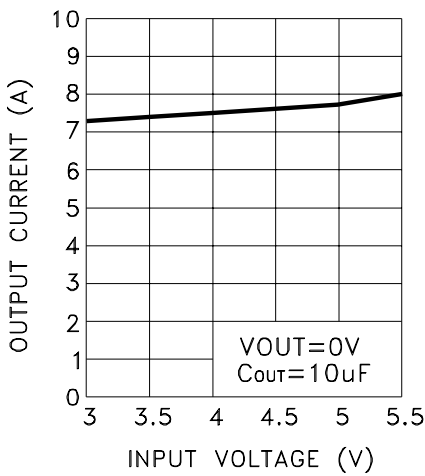

TURN-ON TIME

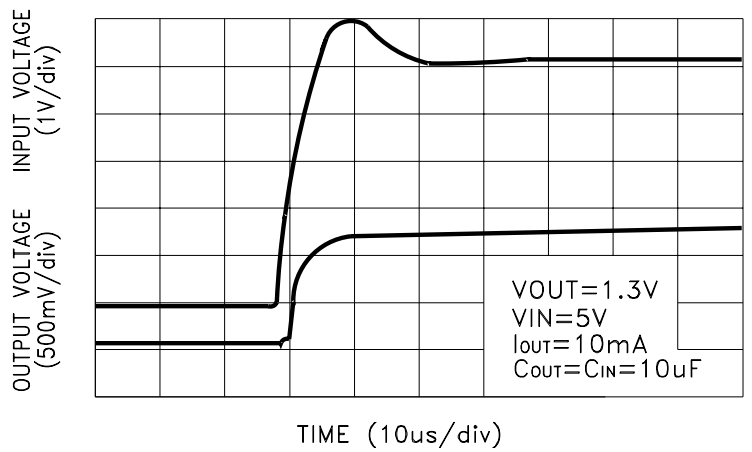

LOAD TRANSIENT

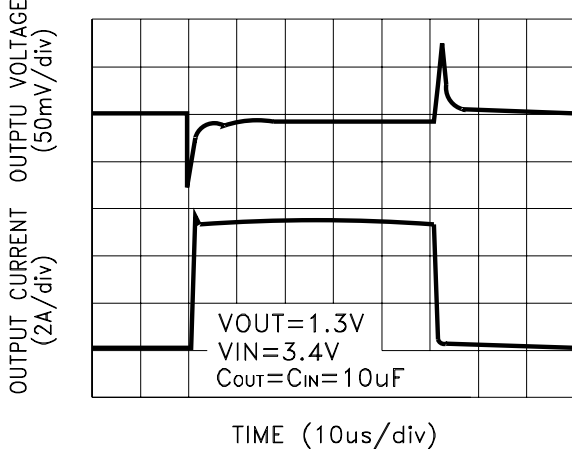

LINE TRANSIENT

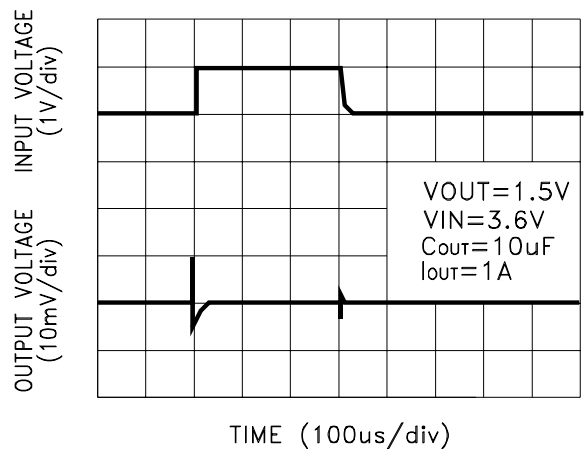

MECHANICAL SPECIFICATIONS

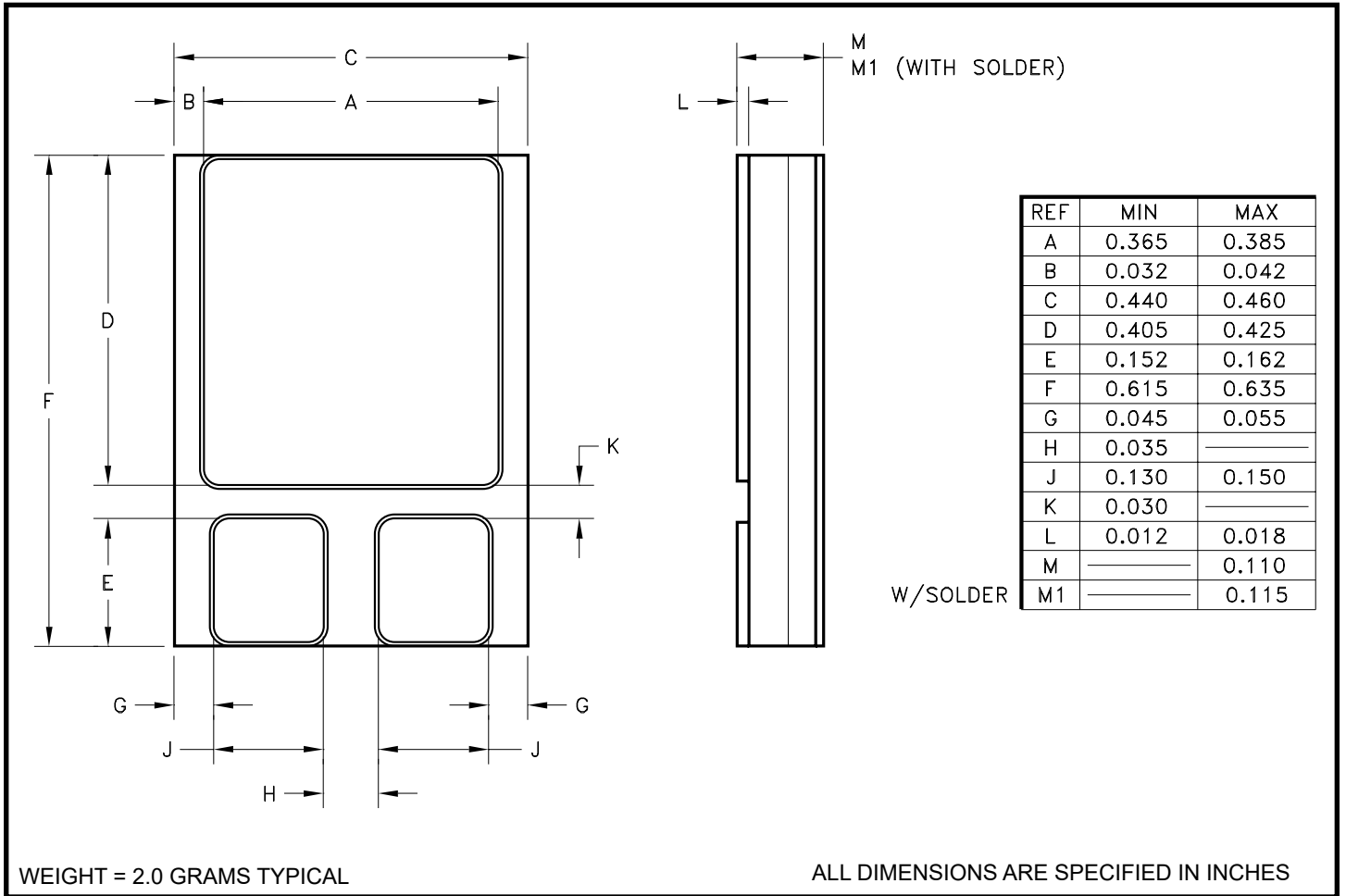

ORDERING INFORMATION

MSK5251-1.3 H

SCREENING
 BLANK = INDUSTRIAL; H = MIL-PRF-38534 CLASS H

OUTPUT VOLTAGE
 0.8 = +0.8V; 0.9 = +0.9V; 1.0 = +1.0V; 1.2 = +1.2V;
 1.3 = +1.3V; 1.4 = +1.4V; 1.5 = +1.5V

GENERAL PART NUMBER

The above example is a +1.3V, Military regulator.

REVISION HISTORY

REV	STATUS	DATE	DESCRIPTION
I	Released	04/14	Add form #, clarify mechanical specifications and correct 1.2V part number
J	Released	04/23	Remove MIL-PRF-38535 and update company name and website

TTM Technologies

www.ttm.com

The information contained herein is believed to be accurate at the time of printing. TTM Technologies reserves the right to make changes to its products or specifications without notice, however and assumes no liability for the use of its products. Please visit our website for the most recent revision of this data sheet.