



M.S.KENNEDY CORP.

**RAD HARD ULTRA LOW
DROPOUT ADJUSTABLE
POSITIVE LINEAR REGULATOR**

5800RH

FEATURES:

- Manufactured using  Space Qualified RH1573 Die
- New "Harder" Version of MSK5900RH
- Total Dose Hardened to 300 Krads(Si)
- Ultra Low Dropout for Reduced Power Consumption
- External Shutdown/Reset Function
- Latching Overload Protection
- Adjustable Output Using Two External Resistors
- Output Current Limit
- Surface Mount Package
- Available to DSCC SMD 5962F09216
- Low Dose Rate Tested to 100 Krads(Si) (Method 1019.7 Condition D)
- Neutron Tested to 1.0×10^{12} n/cm² (Method 1017.2)

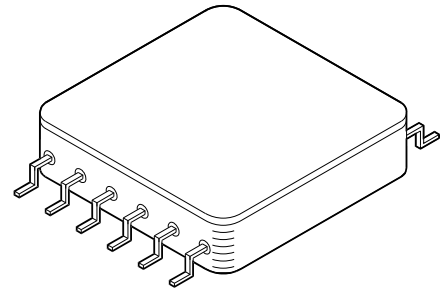

DESCRIPTION:

The MSK5800RH is a rad hard adjustable linear regulator capable of delivering 4.0 amps of output current. Typical dropout is only 0.30 volts with a 1.5 amp load. An external shutdown/reset function is ideal for power supply sequencing. This device also has latching overload protection that requires no external current sense resistor. The MSK5800RH is specifically designed for many space/satellite applications. The device is packaged in a hermetically sealed 12 pin flatpack that is lead formed for surface mount applications.

EQUIVALENT SCHEMATIC

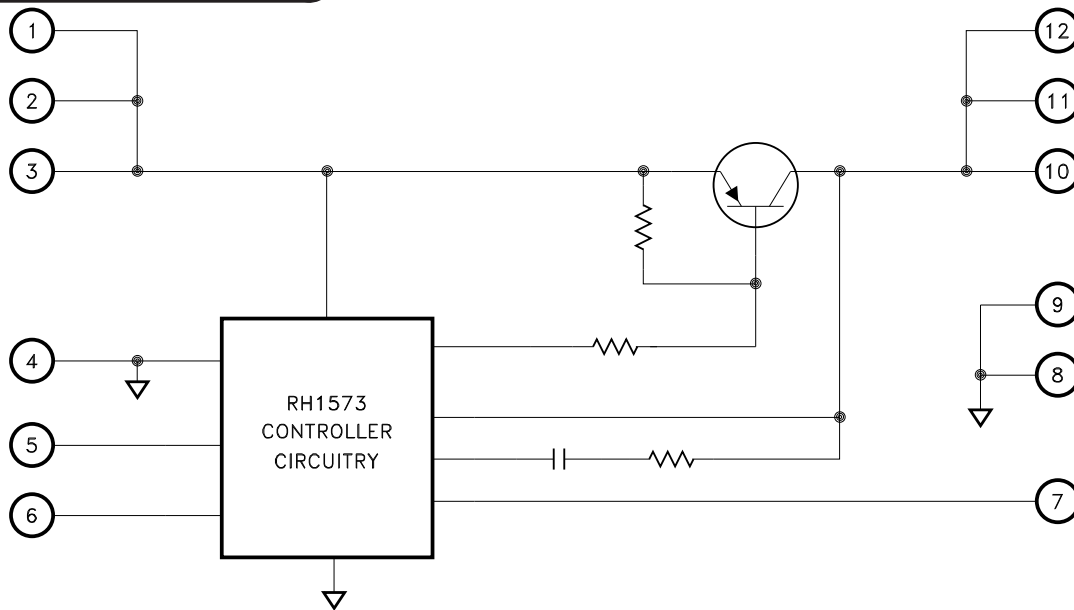

TYPICAL APPLICATIONS

- Satellite System Power Supplies
- Switching Power Supply Post Regulators
- Constant Voltage/Current Regulators
- Microprocessor Power Supplies

PIN-OUT INFORMATION

1 VIN A	12 VOUT A
2 VIN B	11 VOUT B
3 VIN C	10 VOUT C
4 GND 1	9 GND 2
5 LATCH	8 GND 2
6 SHUTDOWN	7 FB

CASE = ISOLATED

 and the Linear Technology logo are registered trademarks and RH1573 is a copyright of Linear Technology Corporation

ABSOLUTE MAXIMUM RATINGS ^⑨

+VIN	Supply Voltage	+10V
V _{SD}	Shutdown Voltage	10V
I _{OUT}	Output Current ^⑦	4A
T _C	Case Operating Temperature Range	
	MSK5800RH K/H	-55°C to +125°C
	MSK5800RH	-40°C to +85°C

T _{ST}	Storage Temperature Range	-65°C to +150°C
T _{LD}	Lead Temperature Range	
	(10 Seconds)	300°C
P _D	Power Dissipation	See SOA Curve
T _C	Junction Temperature	150°C
	ESD Rating	Class 2

ELECTRICAL SPECIFICATIONS

Parameter	Test Conditions ^{① ⑩}	Group A Subgroup	MSK5800K/H			MSK5800			Units
			Min.	Typ.	Max.	Min.	Typ.	Max.	
Input Voltage Range ^{② ⑧}	10mA ≤ I _{OUT} ≤ 1.0A	1	2.9	-	7.5	2.9	-	7.5	V
		2,3	2.9	-	7.5	-	-	-	V
Feedback Voltage	10mA ≤ I _{OUT} ≤ 1.0A R ₁ = 187Ω	1	1.225	1.265	1.305	1.202	1.265	1.328	V
		2,3	1.225	-	1.305	-	-	-	V
		1	1.225	-	1.305	1.202	-	1.328	V
		1	1.225	-	1.310	1.202	-	1.328	V
Feedback Pin Current ^②	V _{FB} = 1.265V 10mA ≤ I _{OUT} ≤ 1.0A	1,2,3	0	-	5.0	0	-	5.0	μA
Quiescent Current	VIN = 7.5V	1	-	14	20	-	14	20	mA
	Not Including I _{OUT}	2,3	-	14	20	-	-	-	mA
Line Regulation	I _{OUT} = 10mA 2.9V ≤ VIN ≤ 7.5V	1	-	±0.01	±0.50	-	0.01	±0.60	%V _{OUT}
	R ₁ = 187Ω	2,3	-	-	±0.50	-	-	-	%V _{OUT}
Load Regulation	10mA ≤ I _{OUT} ≤ 1.0A	1	-	±0.06	±0.80	-	0.06	±1.0	%V _{OUT}
		2,3	-	-	±0.80	-	-	-	%V _{OUT}
Dropout Voltage	Delta FB = 1% I _{OUT} = 1.0A	1	-	0.22	0.70	-	0.22	0.75	V
		2,3	-	0.26	0.70	-	-	-	V
Minimum Output Current ^②	2.9V ≤ VIN ≤ 7.5V	1	-	8	10	-	8	10	mA
	R ₁ = 187Ω	2,3	-	9	10	-	-	-	mA
Output Voltage Range ^②	VIN = 7.5V	-	1.5	-	6.8	1.5	-	6.7	V
Output Current Limit ^⑦	VIN = 4.4V V _{OUT} = 3.3V	1	1.5	1.75	2.0	1.3	1.75	2.2	A
		2,3	1.3	1.75	2.2	-	-	-	A
Shutdown Threshold	V _{OUT} ≤ 0.2V (OFF)	1	1.0	1.3	1.6	1.0	1.3	1.6	V
	V _{OUT} = Nominal (ON)	2,3	1.0	1.3	1.6	-	-	-	V
Shutdown Hysteresis	Difference between voltage threshold of V _{SDI} (ON) and V _{SDI} (OFF)	1	-	0.02	0.2	-	0.02	0.2	V
		2,3	-	0.03	0.2	-	-	-	V
Ripple Rejection ^②	f = 1KHz to 10KHz	4	20	-	-	20	-	-	dB
	10mA ≤ I _{OUT} ≤ 1.0A 1.0V = VIN - V _{OUT}	5,6	20	-	-	-	-	-	dB
Phase Margin ^②	I _{OUT} = 450mA	4,5,6	30	70	-	30	70	-	degrees
Gain Margin ^②	I _{OUT} = 450mA	4,5,6	10	18	-	10	18	-	dB
Equivalent Noise Voltage ^②	Referred to Feedback Pin	4,5,6	-	-	50	-	-	50	μV _{RMS}
Thermal Resistance ^②	Junction to Case @ 125°C Output Device	-	-	6.9	7.5	-	6.9	7.8	°C/W

NOTES:

- ① Unless otherwise specified, VIN = 5.0V, R₁ = 1.62K, V_{SHUTDOWN} = 0V and I_{OUT} = 10mA. See Figure 2, typical application circuit.
- ② Guaranteed by design but not tested. Typical parameters are representative of actual device performance but are for reference only.
- ③ Industrial grade devices shall be tested to subgroups 1 and 4 unless otherwise requested.
- ④ Military grade devices ("H" suffix) shall be 100% tested to subgroups 1,2,3 and 4.
- ⑤ Subgroup 5 and 6 testing available upon request.
- ⑥ Subgroup 1,4 T_C = +25°C
Subgroup 2,5 T_C = +125°C
Subgroup 3,6 T_A = -55°C
- ⑦ Output current limit is dependent upon the values of VIN and V_{OUT}. See Figure 1 and typical performance curves.
- ⑧ Minimum VIN at -55°C and I_{OUT} = 1.0A is 4.0V due to current limit circuitry.
- ⑨ Continuous operation at or above absolute maximum ratings may adversely effect the device performance and/or life cycle.
- ⑩ Pre and post irradiation limits, up to 300Krad TID, are identical unless otherwise specified.
- ⑪ Reference DSCC SMD 5962F09216 for electrical specification for devices purchased as such.

APPLICATION NOTES

PIN FUNCTIONS

VIN A,B,C - These pins provide power to all internal circuitry including bias, start-up, thermal limit and overcurrent latch. Input voltage range is 2.9V to 7.5V. All three pins must be connected for proper operation.

GND1 - Internally connected to input ground, these pins should be connected externally by the user to the circuit ground and the GND2 pins.

LATCH - The MSK5800RH LATCH pin is used for both current limit and thermal limit. A capacitor between the LATCH pin and ground sets a time out delay in the event of an over current or short circuit condition. The capacitor is charged to approximately 1.6V from a 7.2 μ A (nominal) current source. Exceeding the thermal limit charges the latch capacitor from a larger current source for a near instant shutdown. Once the latch capacitor is charged the device latches off until the latch is reset. Momentarily pull the LATCH pin low, toggle the shutdown pin high then low or cycle the power to reset the latch. Toggling the shutdown pin or cycling the power both disable the device during the reset operation (see SHUTDOWN pin description). Pulling the LATCH pin low immediately enables the device for as long as the LATCH pin is held low plus the time delay to re-charge the latch capacitor whether or not the fault has been corrected. Disable the latch feature by tying the LATCH pin low. With the LATCH pin held low the thermal limit feature is disabled and the current limit feature will force the output voltage to droop but remain active if excessive current is drawn.

SHUTDOWN - There are two functions to the SHUTDOWN pin. It may be used to disable the output voltage or to reset the LATCH pin. To activate the shutdown/reset functions the user must apply a voltage greater than 1.3V to the SHUTDOWN pin. The voltage applied to the SHUTDOWN pin can be greater than the input voltage. The output voltage will turn on when the SHUTDOWN pin is pulled below the threshold voltage. If the SHUTDOWN pin is not used, it should be connected to ground.

FB - The FB pin is the inverting input of the internal error amplifier. The non-inverting input is connected to an internal 1.265V reference. This error amplifier controls the drive to the output transistor to force the FB pin to 1.265V. An external resistor divider is connected to the output, FB pin and ground to set the output voltage.

GND2 - Internally connected to output ground, these pins should be connected externally by the user to the circuit ground and the GND1 pins.

VOUT A,B,C - These are the output pins for the device. All three pins must be connected for proper operation.

POWER SUPPLY BYPASSING

To maximize transient response and minimize power supply transients it is recommended that a 33 μ F minimum tantalum capacitor is connected between VIN and ground. A 0.1 μ F ceramic capacitor should also be used for high frequency bypassing.

OUTPUT CAPACITOR SELECTION

Low ESR output capacitors are required to maintain regulation and stability. Four CWR29FB227 (AVX PN TAZH227K010L) tantalum capacitors in parallel with ceramic decoupling capacitors (0.1 μ F typical) provides sufficient gain and phase margin for most applications. The maximum ESR specification for the CWR29FB227 capacitor is 180m Ω at 100kHz and is sufficient for many applications. MSK has found through full WCCA on the MSK5820RH-1.5 that screening for a maximum ESR of 57m Ω ensures EOL stability criteria to be met for many applications with the most stringent requirements. Analysis of the final design is recommended to ensure stability requirements are met.

START UP CURRENT

The MSK5800RH sinks increased current during startup to bring up the output voltage. Reference the "Saturated Drive Current vs. Input Voltage" graph in the typical performance curves of this data sheet and the "Understanding Startup Surge Current With MS Kennedy's RH1573 Based Rad Hard LDO Regulators" application note in the application notes section of the MS Kennedy Web site for more information.

<http://www.mskennedy.com/>

OVERCURRENT LATCH-OFF/LATCH PIN CAPACITOR SELECTION

As previously mentioned, the LATCH pin provides over current/output short circuit protection with a timed latch-off circuit. Reference the LATCH pin description note. The latch off time out is determined with an external capacitor connected from the LATCH pin to ground. The time-out period is equal to the time it takes to charge this external capacitor from 0V to 1.6V. The latch charging current is provided by an internal current source. This current is a function of input voltage and temperature (see latch charging current curve). For instance, at 25 $^{\circ}$ C, the latch charging current is 7.2 μ A at VIN = 3V and 8 μ A at VIN = 7V. In the latch-off mode, some additional current will be drawn from the input. This additional latching current is also a function of input voltage and temperature (see latching current curves).

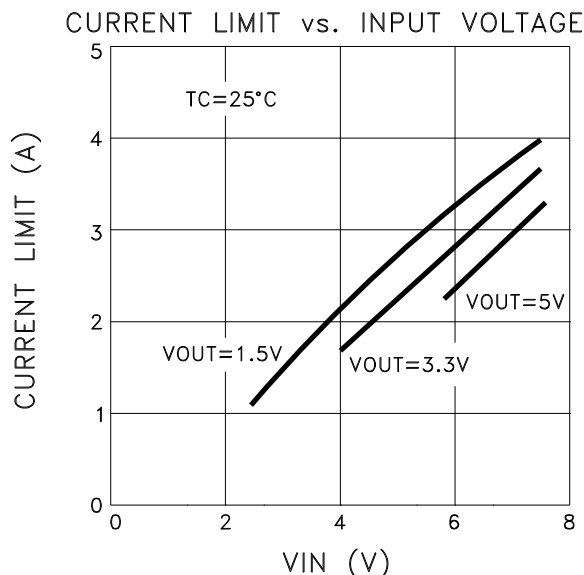

FIGURE 1

The MSK5800RH current limit function is directly affected by the input and output voltages. Figure 1 illustrates the relationship between VIN and ICL for three output voltages.

THERMAL LIMITING

The MSK5800RH control circuitry has a thermal shut-down temperature of approximately 150°C. This thermal shutdown can be used as a protection feature, but for continuous operation, the junction temperature of the pass transistor must be maintained below 150°C. Proper heat sink selection is essential to maintain these conditions. Exceeding the thermal limit activates the latch feature of the MSK5800RH. See LATCH pin description for instructions to reset the latch or disable the latch feature.

HEAT SINK SELECTION

To select a heat sink for the MSK5800RH, the following formula for convective heat flow may be used.

Governing Equation:

$$T_J = P_D \times (R_{\theta JC} + R_{\theta CS} + R_{\theta SA}) + T_A$$

Where

- T_J = Junction Temperature
- P_D = Total Power Dissipation
- R_{θJC} = Junction to Case Thermal Resistance
- R_{θCS} = Case to Heat Sink Thermal Resistance
- R_{θSA} = Heat Sink to Ambient Thermal Resistance
- T_A = Ambient Temperature

$$\text{Power Dissipation} = (V_{IN} - V_{OUT}) \times I_{OUT}$$

Next, the user must select a maximum junction temperature. The absolute maximum allowable junction temperature is 150°C. The equation may now be rearranged to solve for the required heat sink to ambient thermal resistance (R_{θSA}).

Example:

An MSK5800RH is connected for V_{IN} = +5V and V_{OUT} = +3.3V. I_{OUT} is a continuous 1A DC level. The ambient temperature is +25°C. The maximum desired junction temperature is +125°C.

R_{θJC} = 7.5°C/W and R_{θCS} = 0.15°C/W for most thermal greases

$$\text{Power Dissipation} = (5V - 3.3V) \times (1A) = 1.7\text{Watts}$$

Solve for R_{θSA}:

$$R_{\theta SA} = \left[\frac{125^\circ\text{C} - 25^\circ\text{C}}{1.7\text{W}} \right] - 7.5^\circ\text{C/W} - 0.15^\circ\text{C/W} = 51.2^\circ\text{C/W}$$

In this example, a heat sink with a thermal resistance of no more than 51°C/W must be used to maintain a junction temperature of no more than 125°C.

TYPICAL APPLICATIONS CIRCUIT

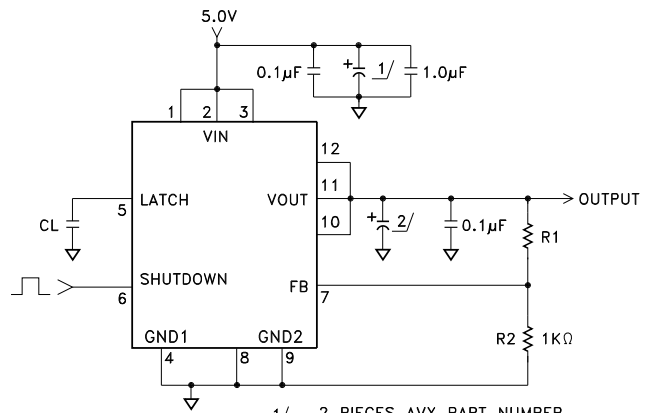

- 1/ 2 PIECES AVX PART NUMBER TAZH476K020C (CWR19JC476K)
- 2/ 4 PIECES AVX PART NUMBER TAZH227K010L (CWR29FB227)

$$V_{OUT} = 1.265(1 + R_1/R_2)$$

OUTPUT VOLTAGE SELECTION

As noted in the above typical applications circuit, the formula for output voltage selection is

$$V_{OUT} = 1.265 \left[1 + \frac{R_1}{R_2} \right]$$

A good starting point for this output voltage selection is to set R₂ = 1K. By rearranging the formula it is simple to calculate the final R₁ value.

$$R_1 = R_2 \left[\frac{V_{OUT}}{1.265} - 1 \right]$$

Table 1 below lists some of the most probable resistor combinations based on industry standard usage.

TABLE 1

OUTPUT VOLTAGE (V)	R ₂ (Ω)	R ₁ (nearest 1%) (Ω)
1.5	1K	187
1.8	1K	422
2.0	1K	576
2.5	1K	976
2.8	1K	1.21K
3.3	1K	1.62K
4.0	1K	2.15K
5.0	1K	2.94K

TOTAL DOSE RADIATION TEST PERFORMANCE

Radiation performance curves for TID testing have been generated for all radiation testing performed by MS Kennedy. These curves show performance trends throughout the TID test process and can be located in the MSK5810RH radiation test report. The complete radiation test report is available in the RAD HARD PRODUCTS section on the MSK website.

Reference the MSK5826RH RAD REPORT for Low Dose Rate and Neutron results.

TYPICAL PERFORMANCE CURVES

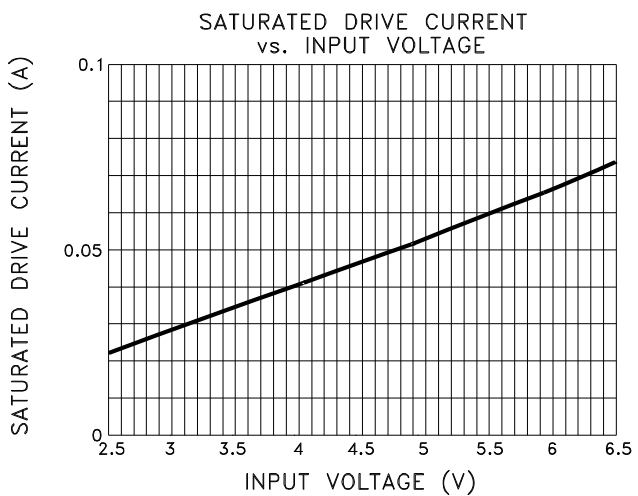
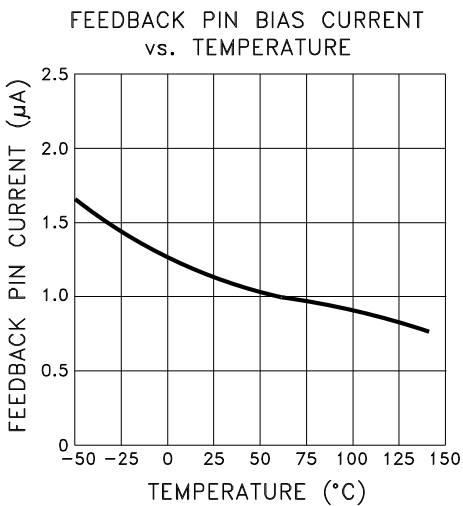
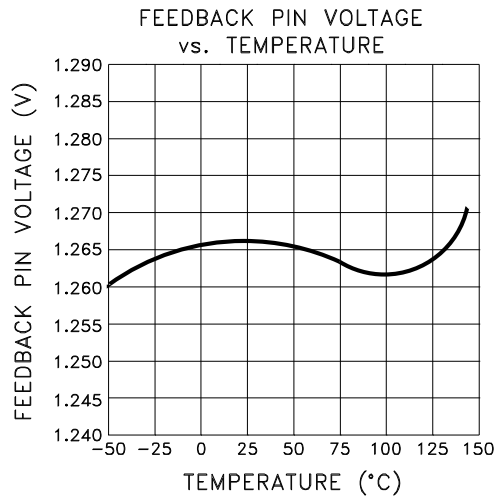
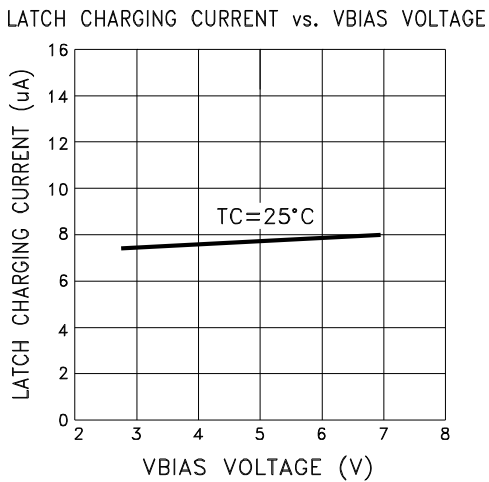
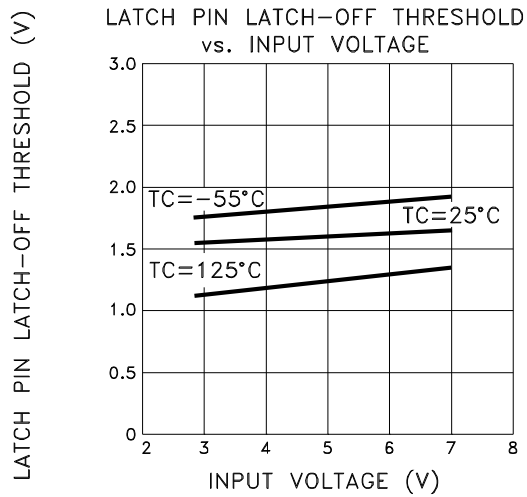
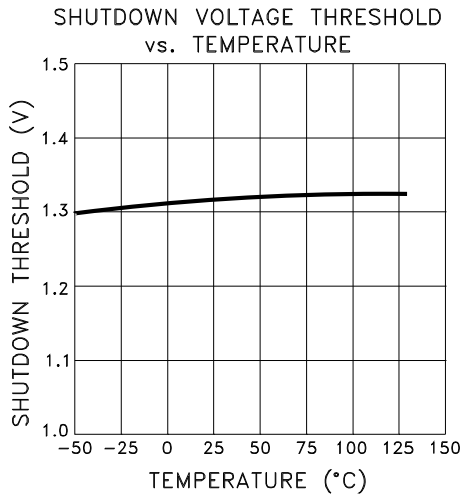

TYPICAL PERFORMANCE CURVES CONT'D

LATCHING CURRENT vs. INPUT VOLTAGE

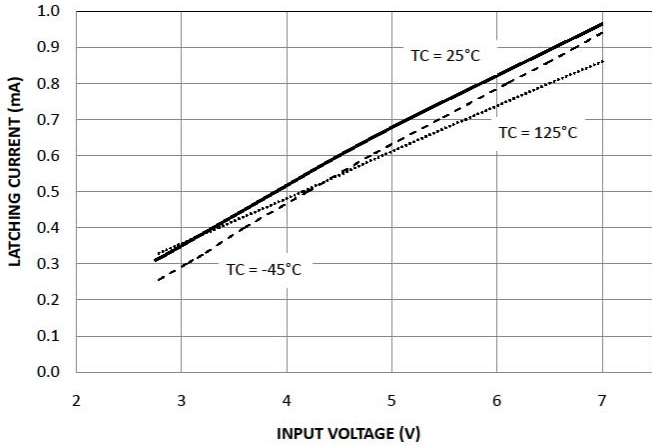

SHUTDOWN PIN CURRENT vs. SHUTDOWN PIN VOLTAGE

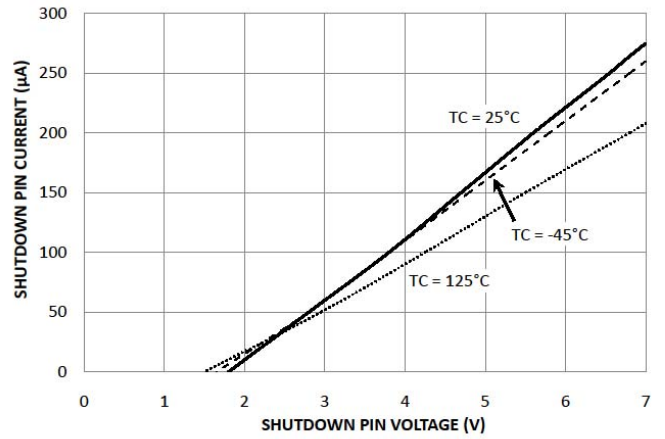

SOA OUTPUT CURRENT vs. VOLTAGE DROP

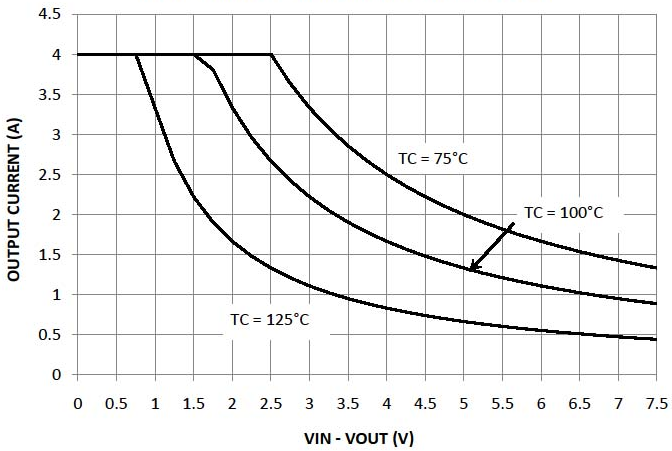

DROPOUT VOLTAGE vs. OUTPUT CURRENT

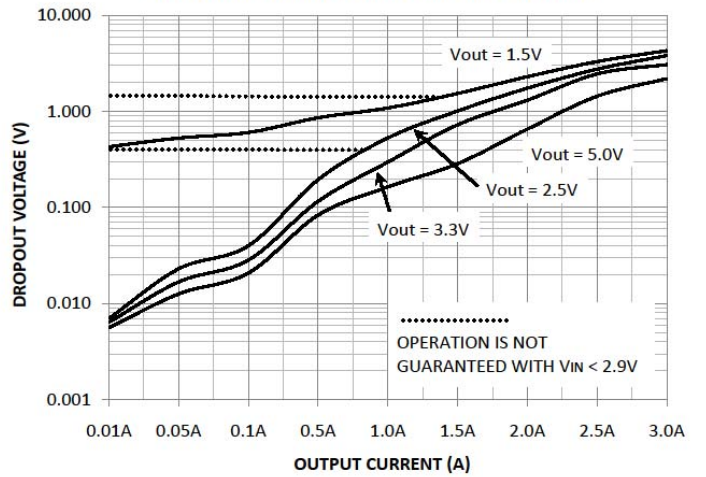

TYPICAL PERFORMANCE CURVES

GAIN AND PHASE RESPONSE

The gain and phase response curves are for the MSK typical application circuit and are representative of typical device performance, but are for reference only. The performance should be analyzed for each application to insure individual program requirements are met. External factors such as temperature, input and output voltages, capacitors, etc. all can be major contributors. Please consult factory for additional details.

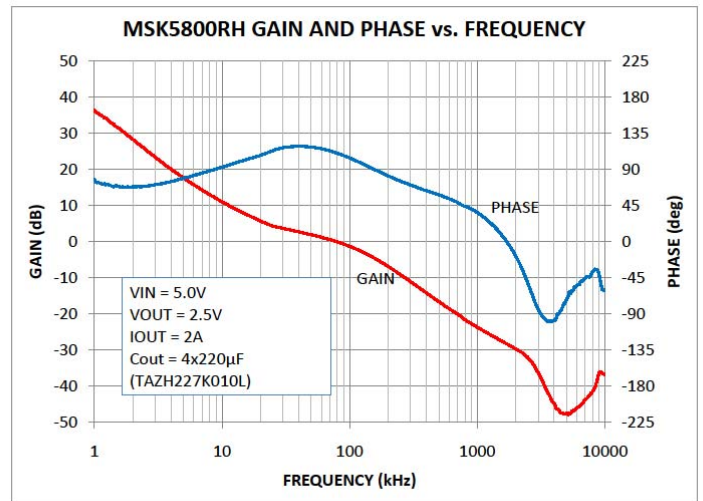
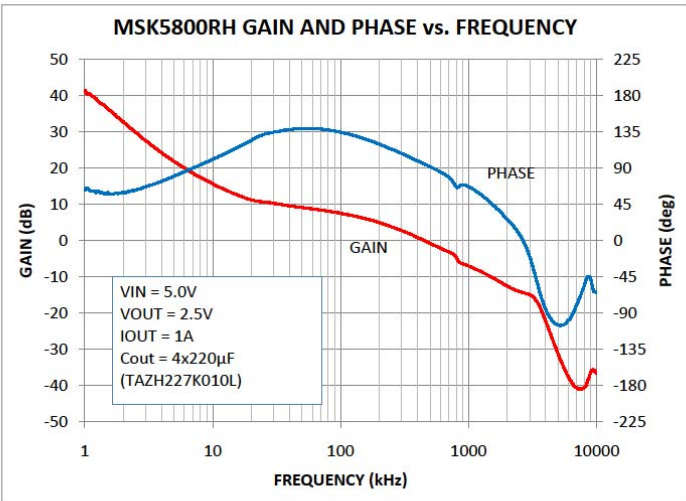
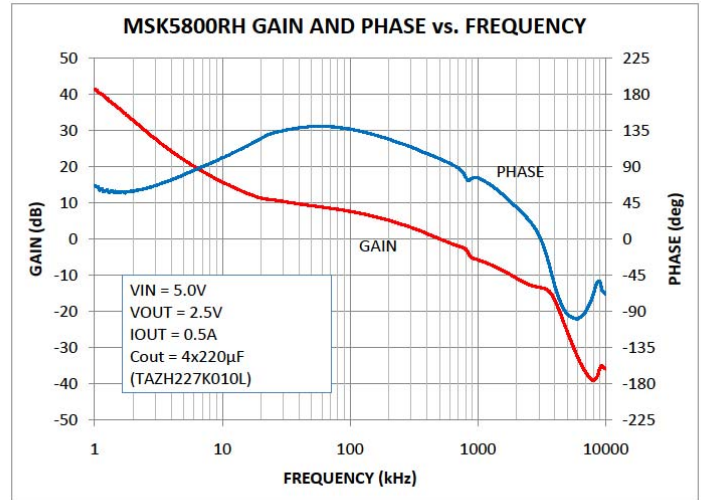
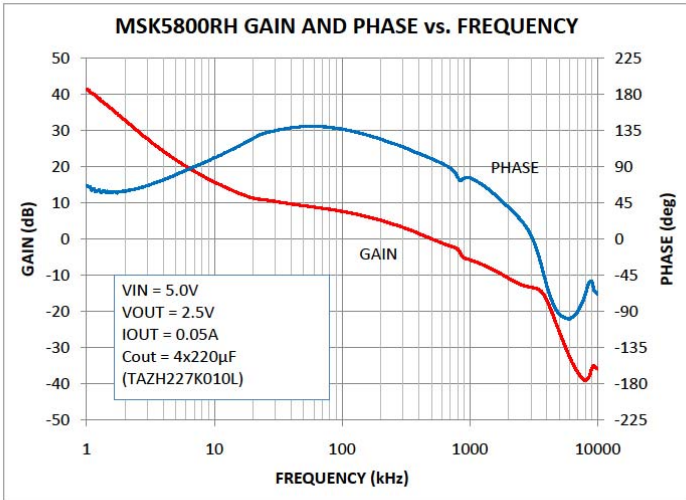

TYPICAL PERFORMANCE CURVES CONT'D

GAIN AND PHASE RESPONSE

The gain and phase response curves are for the MSK typical application circuit and are representative of typical device performance, but are for reference only. The performance should be analyzed for each application to insure individual program requirements are met. External factors such as temperature, input and output voltages, capacitors, etc. all can be major contributors. Please consult factory for additional details.

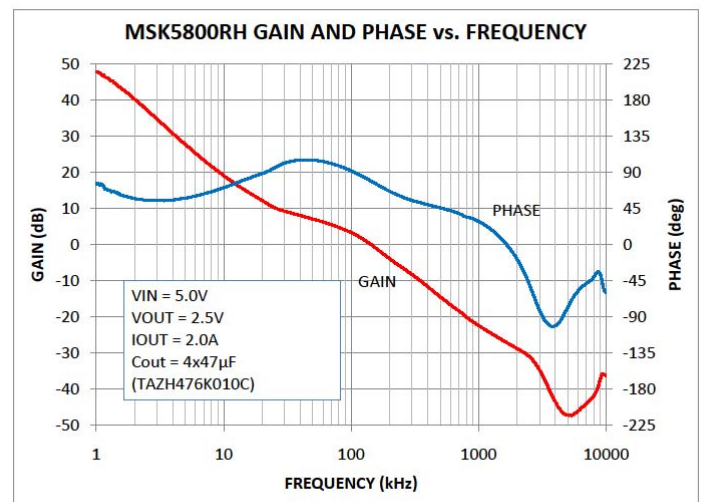
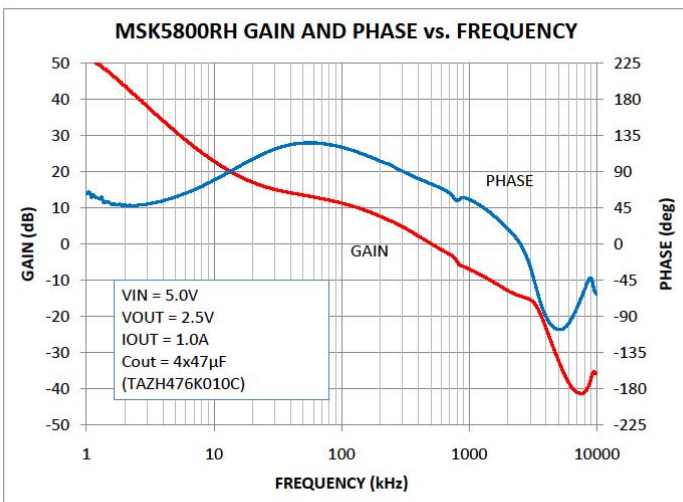
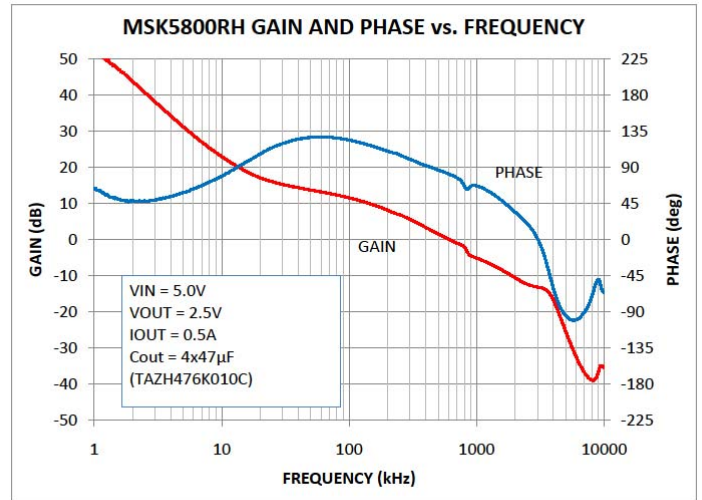
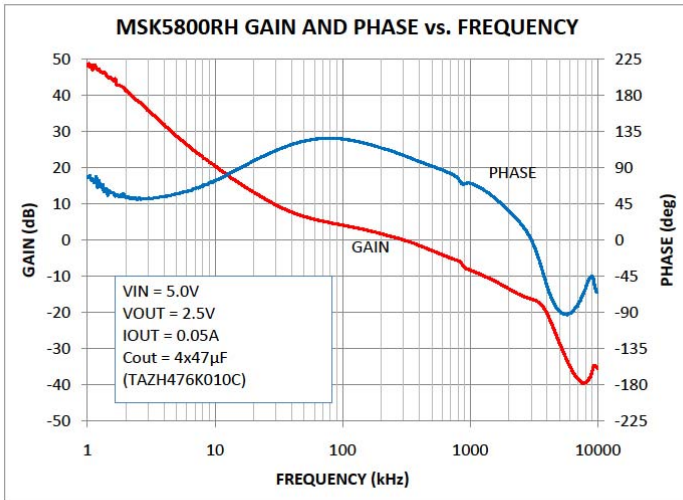

MECHANICAL SPECIFICATIONS

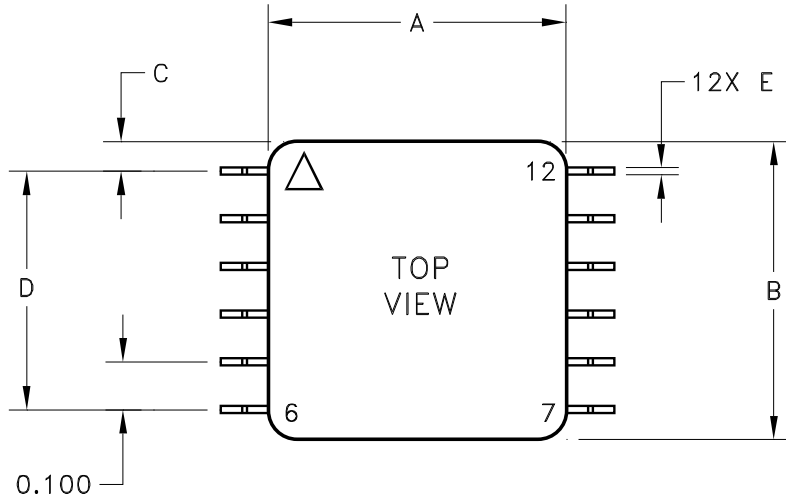

REF	MIN	MAX
A	0.620	0.630
B	0.620	0.630
C	0.0575	0.0675
D	0.495	0.505
E	0.012	0.018
F	0.007	0.013
G	0.045	0.055
H	0.045	0.055
I	0.720	0.730
J	0.820	0.830
K	0.015	0.019
K	0.012	0.018
L		0.160

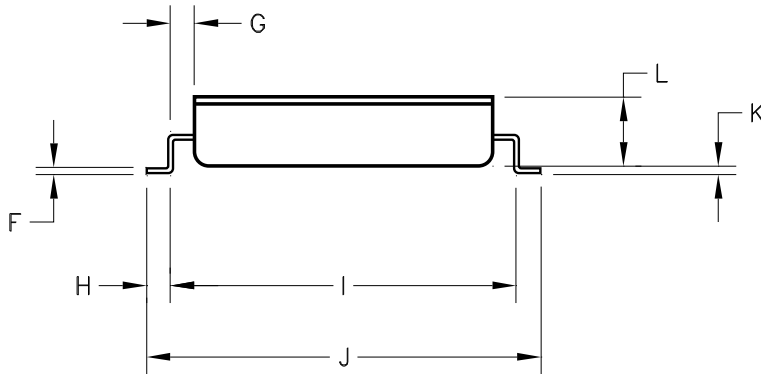

ESD TRIANGLE INDICATES PIN 1
WEIGHT = 3.3 GRAMS TYPICAL

ALL DIMENSIONS ARE SPECIFIED IN INCHES

ORDERING INFORMATION

Part Number	Screening Level
MSK5800RH	INDUSTRIAL
MSK5800HRH	MIL-PRF-38534 CLASS H
MSK5800KRH	MIL-PRF-38534 CLASS K
DSCC SMD	5962F09216

REVISION HISTORY

REV	STATUS	DATE	DESCRIPTION
J	Released	05/14	Update mechanical outline and add ESD rating.
K	Released	06/14	Add shutdown pin to absolute maximum ratings and comment in shutdown pin description.

M.S. Kennedy Corp.
Phone (315) 701-6751
FAX (315) 701-6752
www.mskennedy.com

The information contained herein is believed to be accurate at the time of printing. MSK reserves the right to make changes to its products or specifications without notice, however, and assumes no liability for the use of its products. Please visit our website for the most recent revision of this datasheet.