



M.S.KENNEDY CORP.

**RAD HARD ULTRA LOW  
DROPOUT ADJUSTABLE  
POSITIVE LINEAR REGULATOR**

**5910RH**

**FEATURES:**

- Total Dose Hardened to 100 Krads(Si) (Method 1019.7 Condition A)
- Ultra Low Dropout for Reduced Power Consumption
- External Shutdown/Reset Function
- Latching Overload Protection
- Adjustable Output Using Two External Resistors
- Output Current Limit
- Surface Mount Package Available with Lead Forming
- Low Input Voltage for Maximum Efficiency
- Up to 5A Output Current
- Available as SMD 5962R05220
- RAD Certified by DSCC

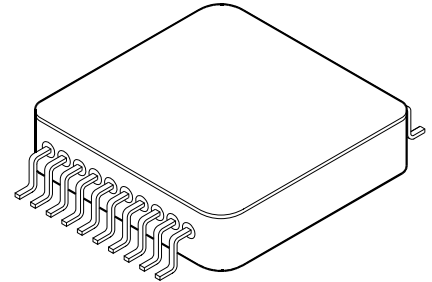

**DESCRIPTION:**

The MSK5910RH is a rad hard adjustable linear regulator capable of delivering 5.0 amps of output current. The typical dropout is only 0.11 volts at 1 amp. An external shutdown/reset function is ideal for power supply sequencing. This device also has latching overload protection that requires no external current sense resistor. The MSK5910RH is radiation hardened and specifically designed for many space/satellite applications. The device is packaged in a hermetically sealed 20 pin flatpack that can be lead formed for surface mount applications.

**EQUIVALENT SCHEMATIC**

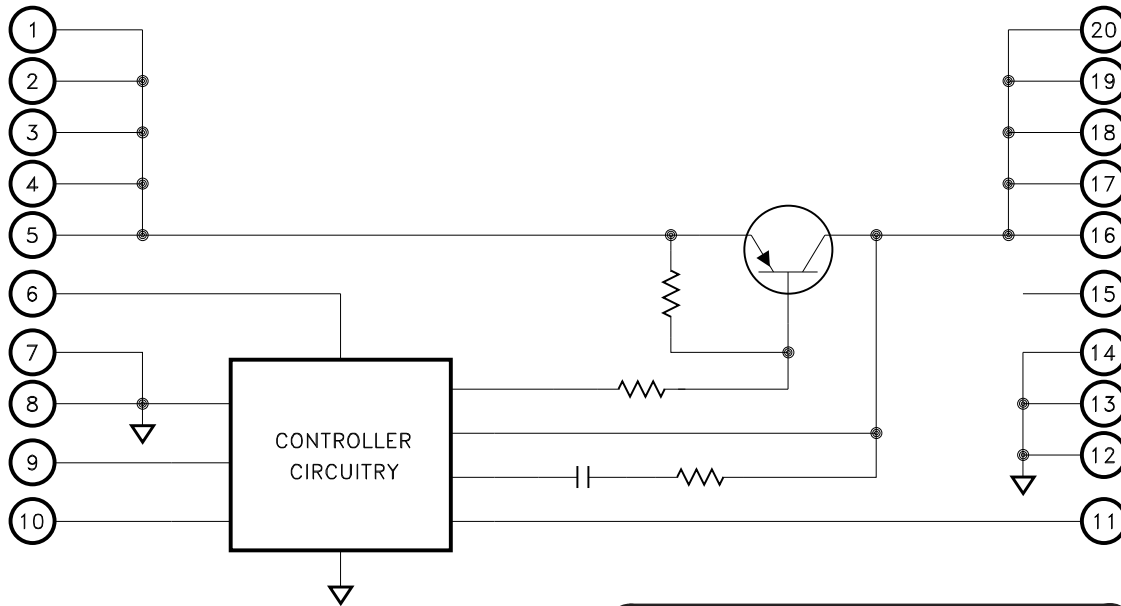

**TYPICAL APPLICATIONS**

- Satellite System Power Supplies
- Switching Power Supply Post Regulators
- Constant Voltage/Current Regulators
- Microprocessor Power Supplies

**PIN-OUT INFORMATION**

1 VINA	20 VOUTE
2 VINB	19 VOUTD
3 VINC	18 VOUTC
4 VIND	17 VOUTB
5 VINE	16 VOUTA
6 VBIAS	15 NC
7 GND1	14 GND2
8 GND1	13 GND2
9 Latch	12 GND2
10 Shutdown	11 FB

CASE = ISOLATED

## ABSOLUTE MAXIMUM RATINGS <sup>⑧</sup>

+V <sub>BIAS</sub>	Bias Supply Voltage	10V	T <sub>ST</sub>	Storage Temperature Range	-65°C to +150°C
+V <sub>IN</sub>	Supply Voltage	10V	T <sub>LD</sub>	Lead Temperature Range	(10 Seconds)
V <sub>SD</sub>	Shutdown Voltage	10V	P <sub>D</sub>	Power Dissipation	See SOA Curve
I <sub>OUT</sub>	Output Current <sup>⑦</sup>	5A	T <sub>C</sub>	Junction Temperature	150°C
T <sub>C</sub>	Case Operating Temperature Range				
	MSK5910K/H RH	-55°C to +125°C			
	MSK5910RH	-40°C to +85°C			

## ELECTRICAL SPECIFICATIONS <sup>⑩</sup>

Parameter	Test Conditions <sup>①⑨</sup>	Group A Subgroup	MSK5910K/H			MSK5910			Units
			Min.	Typ.	Max.	Min.	Typ.	Max.	
Input Voltage Range <sup>②</sup>	10mA ≤ I <sub>OUT</sub> ≤ 1.0A	1,2,3	2.0	-	7.5	2.0	-	7.5	V
Input Bias Voltage <sup>②</sup>	V <sub>BIAS</sub> ≥ V <sub>IN</sub>	1,2,3	2.9	5.0	7.5	2.9	5.0	7.5	V
Feedback Voltage	I <sub>OUT</sub> = 1.0A R1 = 187Ω	1	1.225	1.265	1.305	1.202	1.265	1.328	V
		2,3	1.225	-	1.305	-	-	-	V
		Post Radiation	1	1.215	-	1.315	-	-	-
Feedback Pin Current <sup>②</sup>	V <sub>FB</sub> = 1.265V 10mA ≤ I <sub>OUT</sub> ≤ 1.0A	1,2,3	0	-	5.0	0	-	5.0	μA
Quiescent Current	I <sub>IN</sub> + I <sub>BIAS</sub> , V <sub>BIAS</sub> = V <sub>IN</sub> = 7.5V Not including I <sub>OUT</sub>	1,2,3	-	14	20	-	14	20	mA
Bias Current	V <sub>BIAS</sub> = 7.5V	1,2,3	-	2	4	-	2	4	mA
Line Regulation	I <sub>OUT</sub> = 10mA 2.9V ≤ V <sub>IN</sub> ≤ 7.5V R1 = 187Ω	1	-	±0.01	±0.50	-	0.01	±0.60	%V <sub>OUT</sub>
		2,3	-	-	±0.50	-	-	-	%V <sub>OUT</sub>
Load Regulation	10mA ≤ I <sub>OUT</sub> ≤ 1.0A R1 = 976	1	-	±0.06	±0.80	-	0.06	±1.0	%V <sub>OUT</sub>
		2,3	-	-	±0.80	-	-	-	%V <sub>OUT</sub>
Dropout Voltage	Delta FB = 1% I <sub>OUT</sub> = 1.0A	1	-	0.11	0.40	-	0.11	0.45	V
		2,3	-	0.14	0.40	-	-	-	V
Minimum Output Current <sup>②</sup>	2.9V ≤ V <sub>IN</sub> ≤ 7.5V R1 = 187Ω	1	-	8	10	-	8	10	mA
		2,3	-	9	10	-	-	-	mA
Output Voltage Range <sup>②</sup>	V <sub>IN</sub> = 7.5V	-	1.5	-	7.0	1.5	-	7.0	V
Output Current Limit <sup>⑦</sup>	V <sub>IN</sub> = 2.5V V <sub>OUT</sub> = 1.5V	1	3.2	3.6	4.0	3.2	3.6	4.0	A
		2,3	3.0	-	-	-	-	-	A
Shutdown Threshold	V <sub>OUT</sub> ≤ 0.2V (OFF) V <sub>OUT</sub> = Nominal (ON)	1	1.0	1.3	1.6	1.0	1.3	1.6	V
		2,3	1.0	1.3	1.6	-	-	-	V
Shutdown Hysteresis	Difference between voltage threshold of V <sub>SDI</sub> (ON) and V <sub>SDI</sub> (OFF)	1	-	0.02	0.2	-	0.02	0.2	V
		2,3	-	0.03	0.2	-	-	-	V
Ripple Rejection <sup>②</sup>	f = 1KHz to 10KHz 10mA ≤ I <sub>OUT</sub> ≤ 1.0A 1.0V = V <sub>IN</sub> - V <sub>OUT</sub>	4	20	-	-	20	-	-	dB
		5,6	20	-	-	-	-	-	dB
Phase Margin <sup>②</sup>	I <sub>OUT</sub> = 450mA	4,5,6	30	80	-	30	80	-	degrees
Gain Margin <sup>②</sup>	I <sub>OUT</sub> = 450mA	4,5,6	10	30	-	10	30	-	dB
Equivalent Noise Voltage <sup>②</sup>	Referred to Feedback Pin	4,5,6	-	-	50	-	-	50	μV <sub>RMS</sub>
Thermal Resistance <sup>②</sup>	Junction to Case @ 125°C Output Device	-	-	7.3	8.4	-	7.3	9.0	°C/W

### NOTES:

- ① Unless otherwise specified, V<sub>BIAS</sub> = V<sub>IN</sub> = 5.0V, R1 = 1.62K, V<sub>SHUTDOWN</sub> = 0V and I<sub>OUT</sub> = 10mA. I<sub>OUT</sub> is subtracted from I<sub>Q</sub> measurement. See typical application circuit.
- ② Guaranteed by design but not tested. Typical parameters are representative of actual device performance but are for reference only.
- ③ Industrial grade devices shall be tested to subgroups 1 and 4 unless otherwise requested.
- ④ Military grade devices ("H" suffix) shall be 100% tested to subgroups 1,2,3 and 4.
- ⑤ Subgroup 5 and 6 testing available upon request.
- ⑥ Subgroup 1,4 T<sub>C</sub> = +25°C  
Subgroup 2,5 T<sub>C</sub> = +125°C  
Subgroup 3,6 T<sub>A</sub> = -55°C
- ⑦ Output current limit is tested with a low duty cycle pulse to minimize junction heating and is dependent on the values of V<sub>IN</sub>, V<sub>OUT</sub> and case temperature. See Typical Performance Curves.
- ⑧ Continuous operation at or above absolute maximum ratings may adversely affect the device performance and/or life cycle.
- ⑨ Pre and post irradiation limits at 25°C, up to 100Krad TID, are identical unless otherwise specified.  
Reference DSCC SMD 5962R05220 for electrical specifications for devices purchased as such.

## APPLICATION NOTES

### PIN FUNCTIONS

**VIN A,B,C,D,E** - These pins provide the input power connection to the MSK5910RH. This is the supply that will be regulated to the output. All five pins must be connected for proper operation.

**VBIAS** - This pin provides power to all internal circuitry including bias, start-up, thermal limit and overcurrent latch. VBIAS voltage range is 2.9V to 7.5V. VBIAS should be kept greater than or equal to VIN.

**GND1** - Internally connected to input ground, these pins should be connected externally by the user to the circuit ground and the GND2 pins.

**LATCH** - The MSK5910RH LATCH pin is used for both current limit and thermal limit. A capacitor between the LATCH pin and ground sets a time out delay in the event of an over current or short circuit condition. The capacitor is charged to approximately 1.6V from a 7.2 $\mu$ A (nominal) current source. Exceeding the thermal limit will charge the latch capacitor from a larger current source for a near instant shutdown. Once the latch capacitor is charged the device latches off until the latch is reset. Momentarily pull the LATCH pin low, toggle the shutdown pin high then low or cycle the power to reset the latch. Toggling the shutdown pin or cycling the bias power both disable the device during the reset operation (see SHUTDOWN pin description). Pulling the LATCH pin low immediately enables the device for as long as the LATCH pin is held low plus the time delay to re-charge the latch capacitor whether or not the fault has been corrected. Disable the latch feature by tying the LATCH pin low. With the LATCH pin held low the thermal limit feature is disabled and the current limit feature will force the output voltage to droop but remain active if excessive current is drawn.

**SHUTDOWN** - There are two functions to the SHUTDOWN pin. It may be used to disable the output voltage or to reset the LATCH pin. To activate the shutdown/reset functions the user must apply a voltage greater than 1.3V to the SHUTDOWN pin. The voltage applied to the SHUTDOWN pin can be greater than the input voltage. The output voltage will turn on when the SHUTDOWN pin is pulled below the threshold voltage. If the SHUTDOWN pin is not used, it should be connected to ground.

**FB** - The FB pin is the inverting input of the internal error amplifier. The non-inverting input is connected to an internal 1.265V reference. This error amplifier controls the drive to the output transistor to force the FB pin to 1.265V. An external resistor divider is connected to the output, FB pin and ground to set the output voltage.

**GND2** - Internally connected to output ground, these pins should be connected externally by the user to the circuit ground and the GND1 pins.

**VOU A,B,C,D,E** - These are the output pins for the device. All five pins must be connected for proper operation.

### OUTPUT CAPACITOR SELECTION

Low ESR output capacitors are required to maintain regulation and stability. Four CWR29FB227 (AVX PN TAZH227K010L) tantalum capacitors in parallel with ceramic decoupling capacitors (0.1 $\mu$ F typical) provides sufficient gain and phase margin for most applications. The maximum ESR specification for the CWR29FB227 capacitor is 180m $\Omega$  at 100kHz and is sufficient for many applications. MSK has found through full WCCA on the MSK5820RH-1.5 that screening for a maximum ESR of 57m $\Omega$  ensures EOL stability criteria to be met for many applications with the most stringent requirements. Analysis of the final design is recommended to ensure stability requirements are met.

### POWER SUPPLY BYPASSING

To maximize transient response and minimize power supply transients it is recommended that a 33 $\mu$ F minimum tantalum capacitor is connected between VIN and ground. A 0.1 $\mu$ F ceramic capacitor should also be used for high frequency bypassing.

### START UP OPTIONS

The MSK5910RH starts up and begins regulating immediately when VBIAS and VIN are applied simultaneously. Applying VBIAS before VIN starts the MSK5910RH up in a disabled or latched state. When starting in a latched state the device output can be enabled either by pulling the latch pin low to drain the latch capacitor or pulsing the shutdown pin high. The shutdown pulse duration is partially dependent upon the size of the latch capacitor and should be characterized for each application; 30 $\mu$ s is typically adequate for a 1 $\mu$ F latch capacitor at 25 $^{\circ}$ C. A momentary high pulse on the shutdown pin can be achieved using the RC circuit below if VIN rises rapidly. The resistor and capacitor must be selected based on the required pulse duration, the rise characteristic of VIN and the shutdown pin threshold (see shutdown pin threshold and current curves).

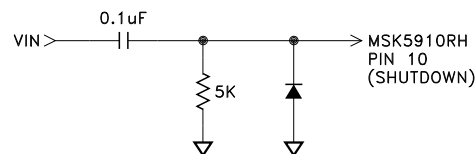

The shutdown pin can be held high and pulled low after VIN comes up or the latch pin held low and released after VIN comes up to ensure automatic startup when applying VBIAS before VIN. Either of the basic circuits below can be adapted to a variety of applications for automatic start up when VBIAS rises before VIN.

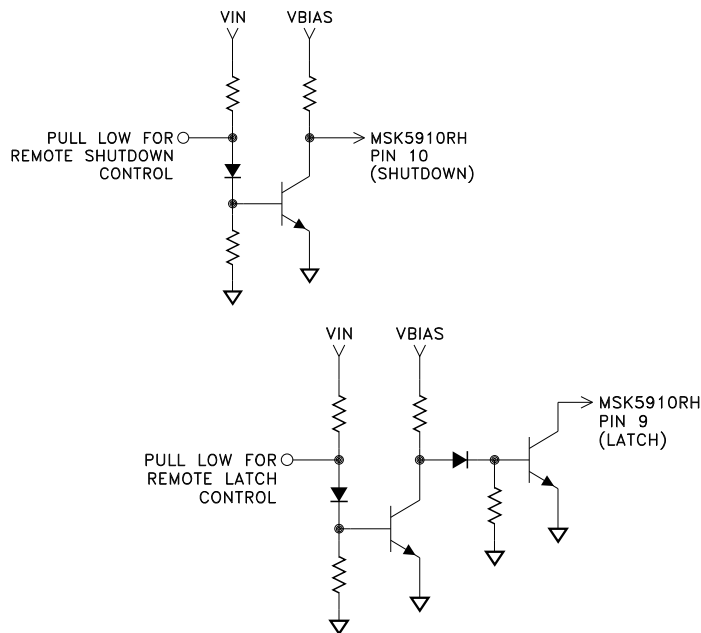

### OVERCURRENT LATCH-OFF/LATCH PIN CAPACITOR SELECTION

As previously mentioned, the LATCH pin provides over current/output short circuit protection with a timed latch-off circuit. Reference the LATCH pin description note. The latch off time out is determined with an external capacitor connected from the LATCH pin to ground. The time-out period is equal to the time it takes to charge this external capacitor from 0V to 1.6V. The latch charging current is provided by an internal current source. This current is a function of bias voltage and temperature (see latch charging current curve). For instance, at 25 $^{\circ}$ C, the latch charging current is 7.2 $\mu$ A at VBIAS = 3V and 8 $\mu$ A at VBIAS = 7V.

In the latch-off mode, some additional current will be drawn from the bias supply. This additional latching current is also a function of bias voltage and temperature (see typical performance curves).

The MSK5910RH current limit function is directly affected by the input and output voltages. Custom current limit is available; contact the factory for more information.

## APPLICATION NOTES CONT.

### THERMAL LIMITING

The MSK5910RH control circuitry has a thermal shut-down temperature of approximately 150°C. This thermal shut-down can be used as a protection feature, but for continuous operation, the junction temperature of the pass transistor must be maintained below 150°C. Proper heat sink selection is essential to maintain these conditions. Exceeding the thermal limit activates the latch feature of the MSK5910RH. See LATCH pin description for instructions to reset the latch or disable the latch feature.

### HEAT SINK SELECTION

To select a heat sink for the MSK5910RH, the following formula for convective heat flow may be used.

#### Governing Equation:

$$T_J = P_D \times (R_{\theta JC} + R_{\theta CS} + R_{\theta SA}) + T_A$$

Where

$T_J$	=	Junction Temperature
$P_D$	=	Total Power Dissipation
$R_{\theta JC}$	=	Junction to Case Thermal Resistance
$R_{\theta CS}$	=	Case to Heat Sink Thermal Resistance
$R_{\theta SA}$	=	Heat Sink to Ambient Thermal Resistance
$T_A$	=	Ambient Temperature

$$\text{Power Dissipation} = (V_{IN} - V_{OUT}) \times I_{OUT}$$

Next, the user must select a maximum junction temperature. The absolute maximum allowable junction temperature is 150°C. The equation may now be rearranged to solve for the required heat sink to ambient thermal resistance ( $R_{\theta SA}$ ).

#### Example:

An MSK5910RH is connected for  $V_{IN} = +5V$  and  $V_{OUT} = +3.3V$ .  $I_{OUT}$  is a continuous 1A DC level. The ambient temperature is +25°C. The maximum desired junction temperature is +125°C.

$R_{\theta JC} = 8.5^\circ\text{C/W}$  and  $R_{\theta CS} = 0.15^\circ\text{C/W}$  for most thermal greases

$$\text{Power Dissipation} = (5V - 3.3V) \times (1A) = 1.7\text{Watts}$$

Solve for  $R_{\theta SA}$ :

$$R_{\theta SA} = \left[ \frac{125^\circ\text{C} - 25^\circ\text{C}}{1.7\text{W}} \right] - 8.4^\circ\text{C/W} - 0.15^\circ\text{C/W} = 50.3^\circ\text{C/W}$$

In this example, a heat sink with a thermal resistance of no more than 50°C/W must be used to maintain a junction temperature of no more than 125°C.

### TYPICAL APPLICATIONS CIRCUIT

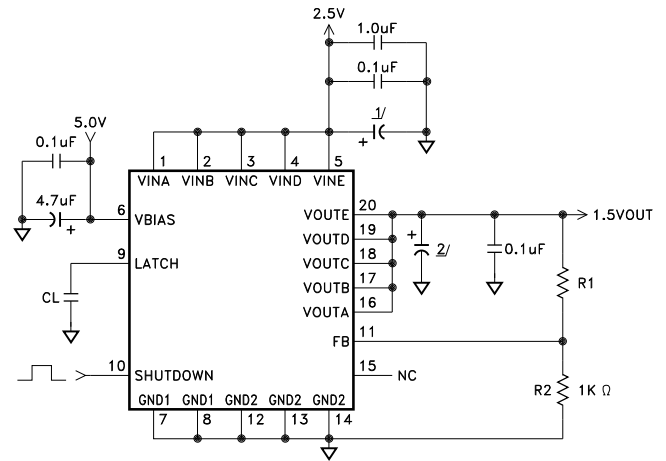

1/ 2 PIECES AVX PART NUMBER TAZH476K020C (CWR19JC476K)

2/ 4 PIECES AVX PART NUMBER TAZH227K010L (CWR29FB227K)

$$V_{OUT} = 1.265(1 + R1/R2)$$

### OUTPUT VOLTAGE SELECTION

As noted in the above typical applications circuit, the formula for output voltage selection is

$$V_{OUT} = 1.265 \left[ 1 + \frac{R1}{R2} \right]$$

A good starting point for this output voltage selection is to set  $R2 = 1K$ . By rearranging the formula it is simple to calculate the final  $R1$  value.

$$R1 = R2 \left[ \frac{V_{OUT}}{1.265} - 1 \right]$$

### START UP CURRENT

The MSK5910RH sinks increased current during startup to bring up the output voltage. Reference the "Saturated Drive Current vs. Input Voltage" graph in the typical performance curves of this data sheet and the "Understanding Startup Surge Current With MS Kennedy's RH1573 Based Rad Hard LDO Regulators" application note in the application notes section of the MS Kennedy Web site for more information.

<http://www.mskennedy.com/>

### TOTAL DOSE RADIATION TEST PERFORMANCE

Radiation performance curves for TID testing have been generated for all radiation testing performed by MS Kennedy. These curves show performance trends throughout the TID test process and can be located in the MSK5910RH radiation test report. The complete radiation test report is available in the RAD HARD PRODUCTS section on the MSK website.

<http://www.mskennedy.com/store.asp?pid=9951&catid=19680>

# TYPICAL PERFORMANCE CURVES

LATCH PIN LATCH-OFF THRESHOLD vs. VBIAS VOLTAGE

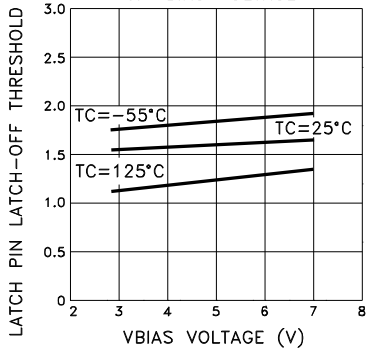

SOA OUTPUT CURRENT vs. VOLTAGE DROP

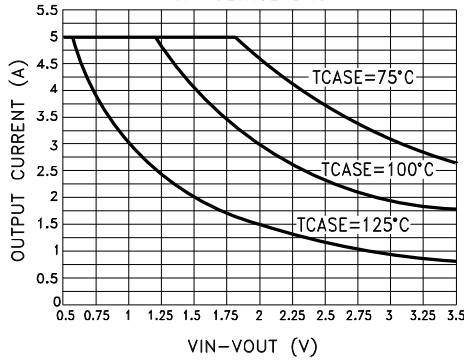

CURRENT LIMIT vs. INPUT VOLTAGE

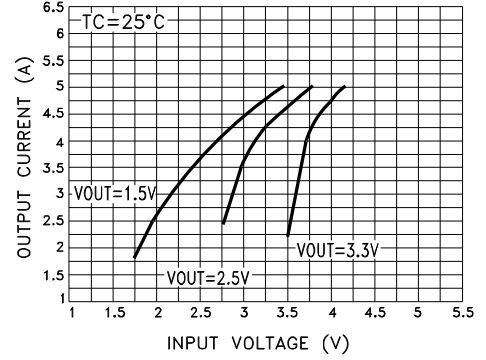

LATCHING CURRENT vs. VBIAS VOLTAGE

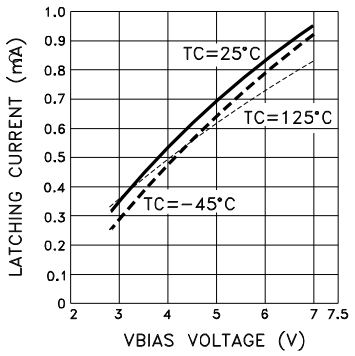

LATCH CHARGING CURRENT vs. VBIAS VOLTAGE

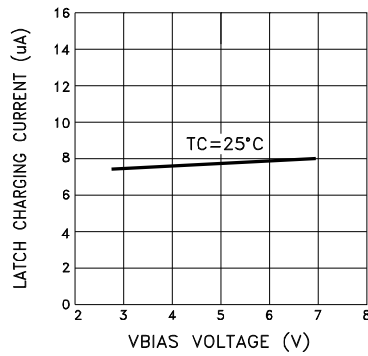

SHUTDOWN VOLTAGE THRESHOLD vs. TEMPERATURE

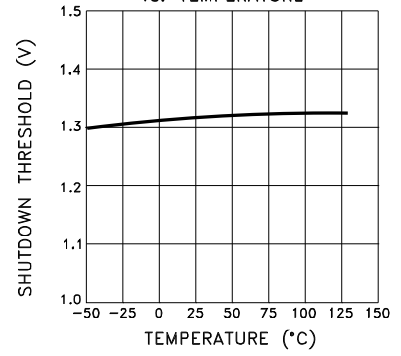

FEEDBACK PIN BIAS CURRENT vs. TEMPERATURE

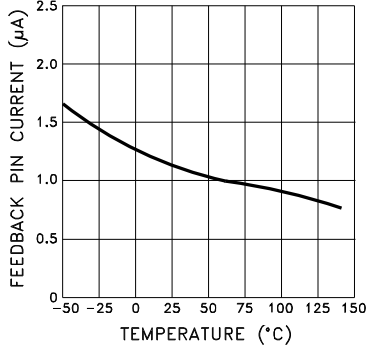

FEEDBACK PIN VOLTAGE vs. TEMPERATURE

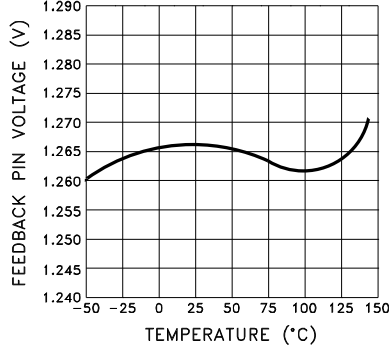

SHUTDOWN PIN CURRENT vs. SHUTDOWN PIN VOLTAGE

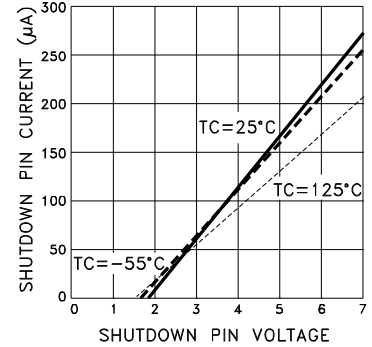

DROPOUT VOLTAGE vs. OUTPUT CURRENT

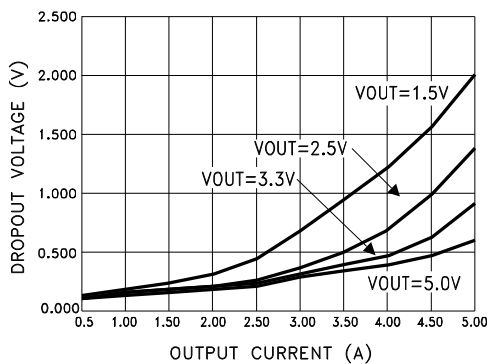

SATURATED DRIVE CURRENT vs. INPUT VOLTAGE

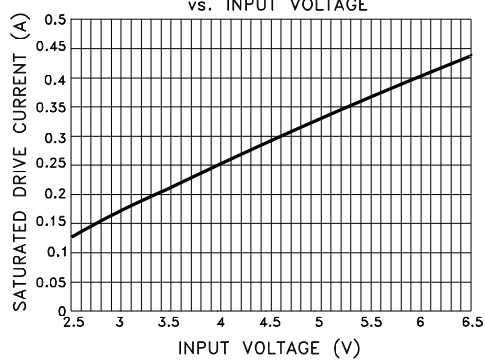

# TYPICAL PERFORMANCE CURVES

## GAIN AND PHASE RESPONSE

The gain and phase response curves are for the MSK typical application circuit and are representative of typical device performance, but are for reference only. The performance should be analyzed for each application to insure individual program requirements are met. External factors such as temperature, input and output voltages, capacitors, etc. all can be major contributors. Please consult factory for additional details.

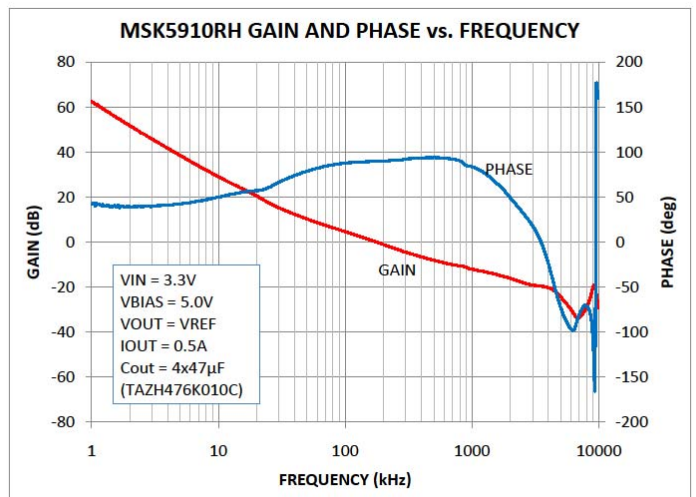
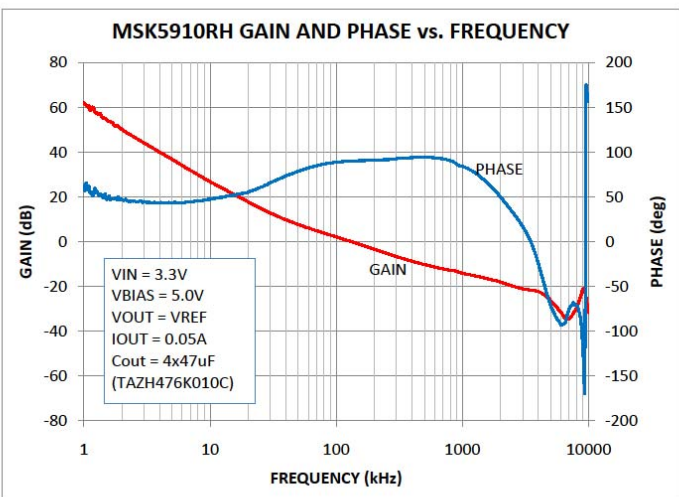
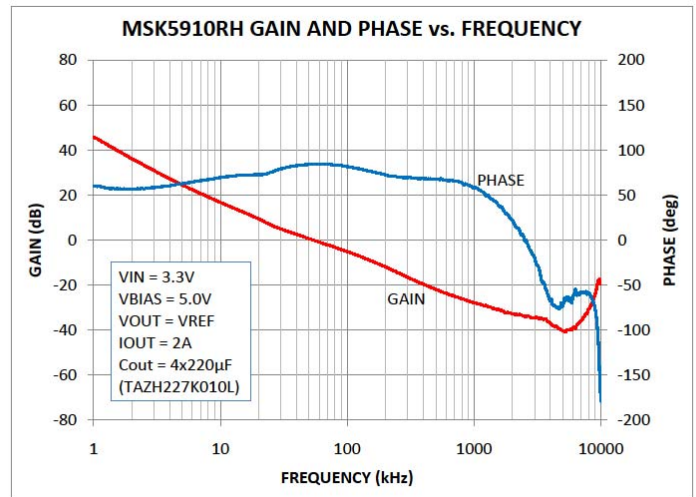
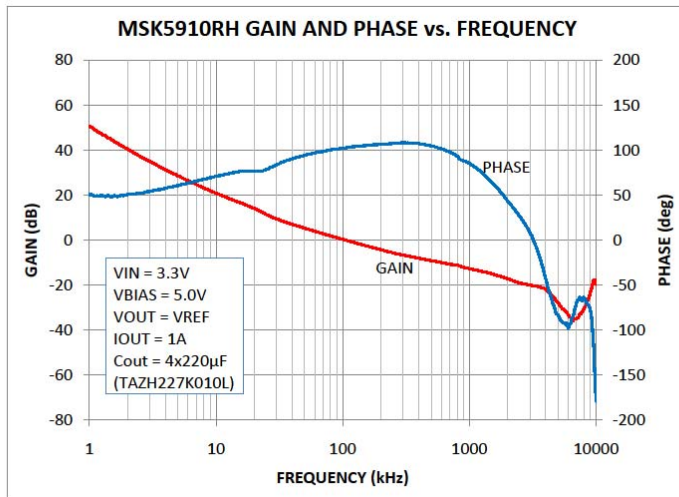
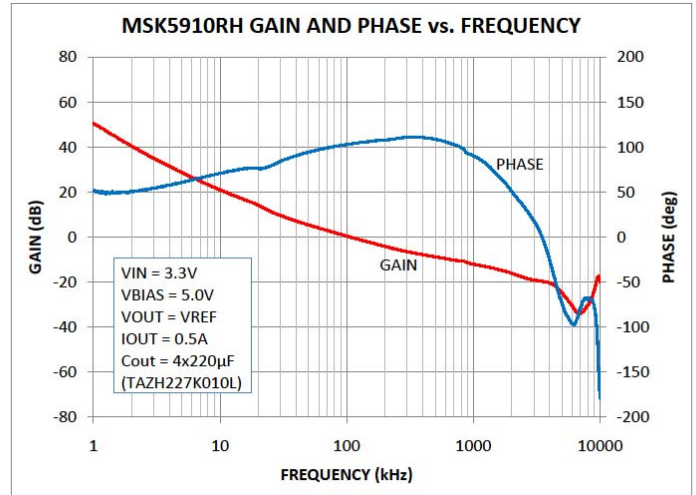
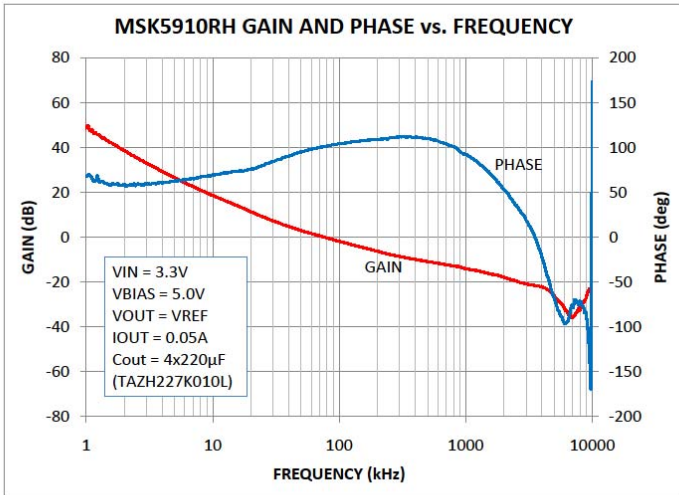

# TYPICAL PERFORMANCE CURVES CONT'D

## GAIN AND PHASE RESPONSE

The gain and phase response curves are for the MSK typical application circuit and are representative of typical device performance, but are for reference only. The performance should be analyzed for each application to insure individual program requirements are met. External factors such as temperature, input and output voltages, capacitors, etc. all can be major contributors. Please consult factory for additional details.

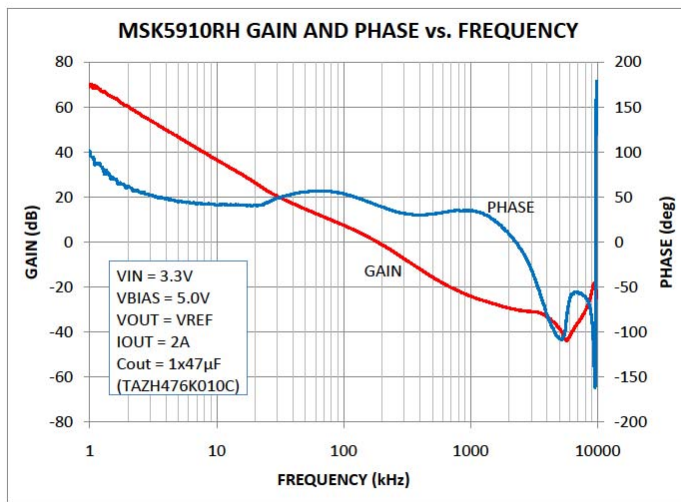
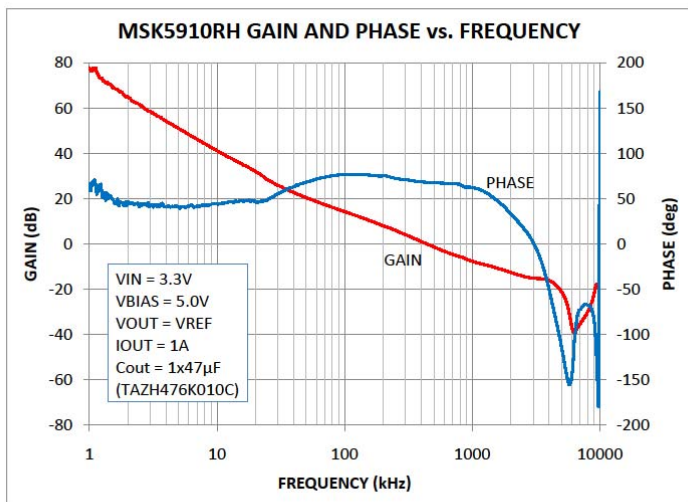
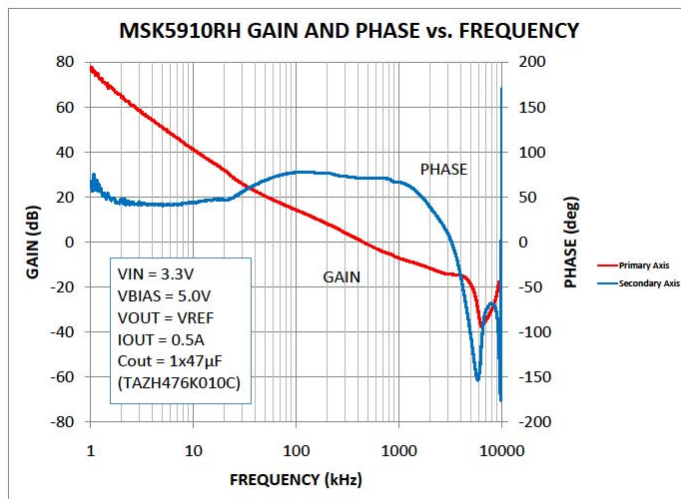
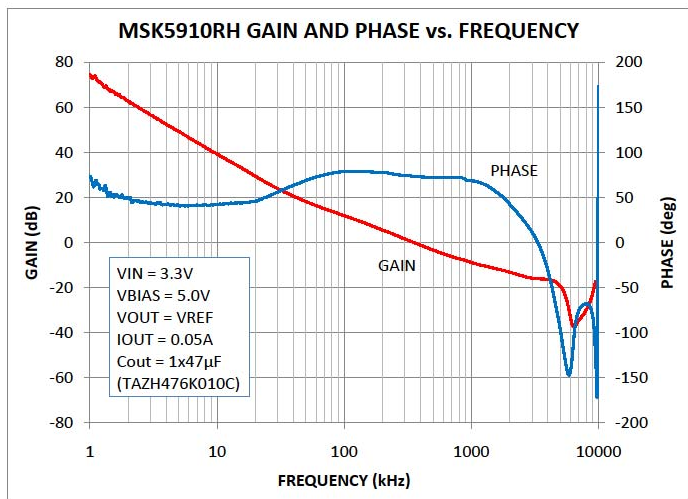
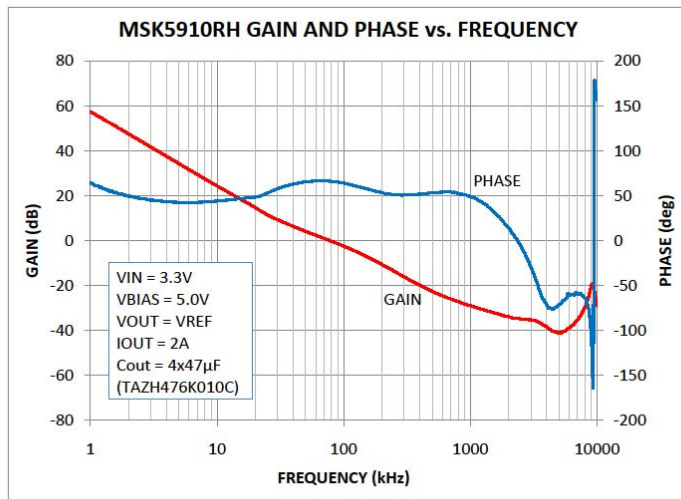
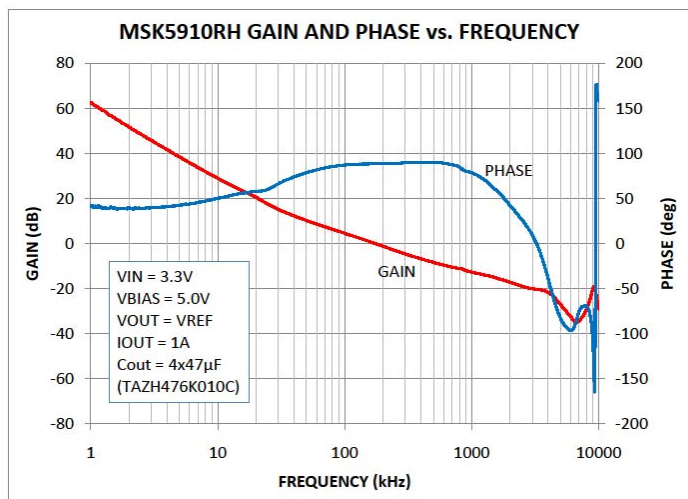

## MECHANICAL SPECIFICATIONS

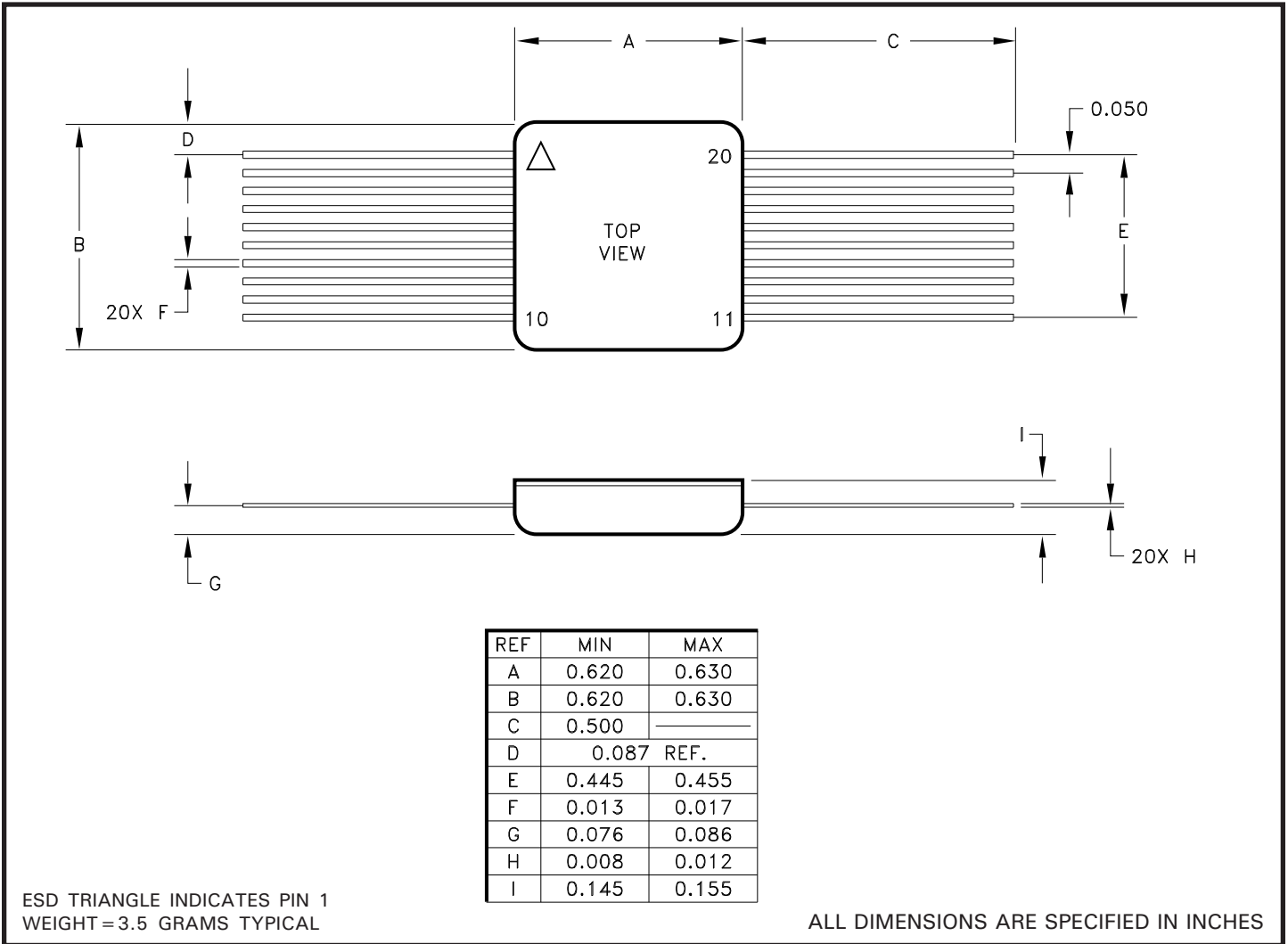

## ORDERING INFORMATION

PART NUMBER	SCREENING LEVEL	LEADS
MSK5910RH	INDUSTRIAL	STRAIGHT
MSK5910HRH	MIL-PRF-38534 CLASS H	
MSK5910KRH	MIL-PRF-38534 CLASS K	
5962R05220	DSCC SMD	



## MECHANICAL SPECIFICATIONS CONTINUED

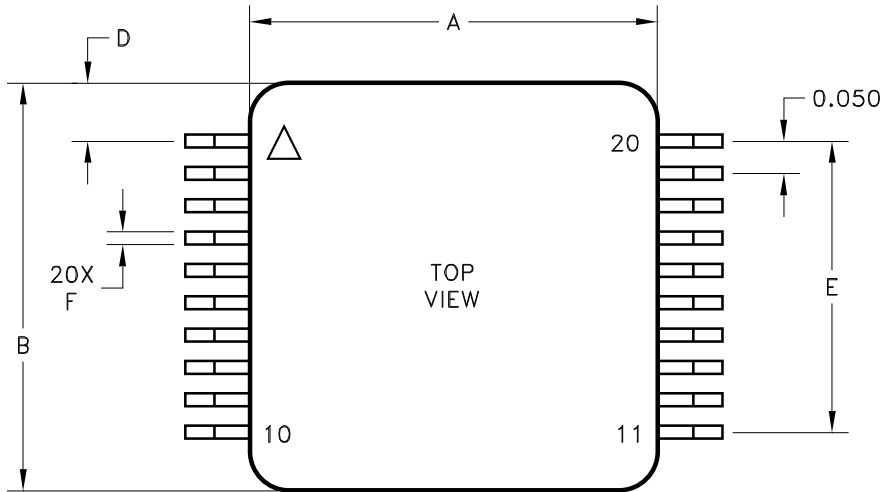

REF	MIN	MAX
A	0.620	0.630
B	0.620	0.630
C	0.045	0.055
D	0.087	REF.
E	0.445	0.455
F	0.013	0.018
G	0.045	0.055
H	0.008	0.012
I		0.155
J	0.008	0.018
K	0.805	0.845

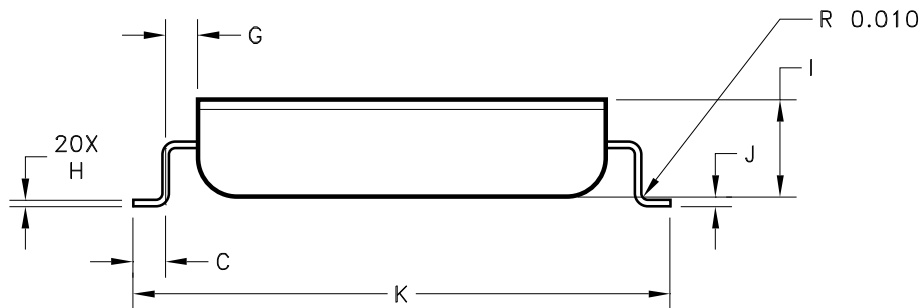

ESD TRIANGLE INDICATES PIN 1  
WEIGHT = 3.3 GRAMS TYPICAL

ALL DIMENSIONS ARE SPECIFIED IN INCHES

## ORDERING INFORMATION

PART NUMBER	SCREENING LEVEL	LEADS
MSK5910RHG	INDUSTRIAL	GULL WING
MSK5910HRHG	MIL-PRF-38534 CLASS H	
MSK5910KRHG	MIL-PRF-38534 CLASS K	
5962R05220	DSCC SMD	

## REVISION HISTORY

REV	STATUS	DATE	DESCRIPTION
S	Released	06/14	Add maximum rating for shutdown input and clarify mechanical outline.

M.S. Kennedy Corp.  
Phone (315) 701-6751  
FAX (315) 701-6752  
[www.mskennedy.com](http://www.mskennedy.com)

---

The information contained herein is believed to be accurate at the time of printing. MSK reserves the right to make changes to its products or specifications without notice, however, and assumes no liability for the use of its products. Please visit our website for the most recent revision of this datasheet.