

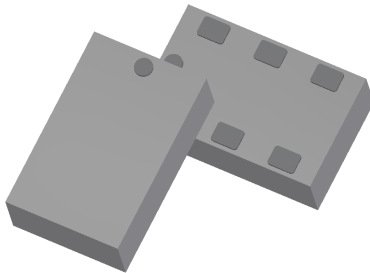

**Ultra Low Profile 0805
10 dB Directional Coupler**

Description:



The DC0710J5010AHF is a low cost, low profile sub-miniature high performance 10 dB Directional coupler in an easy to use RoHS compliant, Halogen Free Xinger style surface mount package. It is designed for 700 – 1000MHz applications including: 5G, LTE and ISM. The DC0710J5010AHF is ideal for power detection, signal injection and other applications where low insertion loss signal monitoring is required. The DC0710J5010AHF is available on tape and reel for pick and place high volume manufacturing.

All of the Xinger components are constructed from ceramic filled PTFE composites which possess excellent electrical and mechanical stability. All parts have been subjected to rigorous Xinger qualification testing and units are 100% RF tested.

Features:

- 700 – 1000 MHz
- Mean Coupling 10dB
- 5G, LTE & ISM
- 0.76mm Height Profile
- Ultra Low Insertion Loss
- Surface Mountable
- Tape & Reel
- RoHS Compliant
- Halogen Free

Electrical Specifications:

Parameter (@25°C)	Min	Typ	Max	Min	Typ	Max	Min	Typ	Max	Unit
Frequency	700		1000	869		894	925		960	MHz
Mean Coupling	11.7	10.9	10.2	11.3	10.7	10.2	11.8	10.9	10.2	dB
Insertion loss		0.21	0.30		0.20	0.29		0.21	0.30	dB
Return Loss	14.2	17.5		15.9	19.4		16.7	19.4		dB
Directivity	17.3	20.1		18.4	22.2		19.1	23.1		dB
Frequency Sensitivity		0.37	0.54		0.03	0.09		0.09	0.12	dB
Power Handling		3			3			3		Watts@105°C
Operating Temp	-55		+140	-55		+140	-55		+140	°C

*Specification based on performance of unit properly installed on microstrip printed circuit boards with 50 Ω nominal impedance. Specifications subject to change without notice.

Outline Drawing:

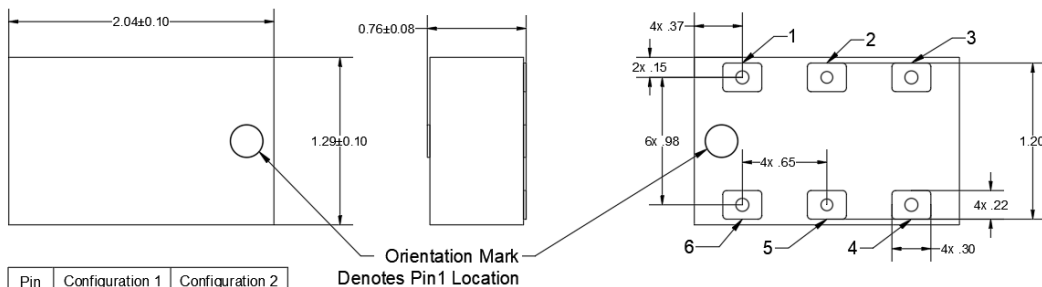

Pin	Configuration 1	Configuration 2
1	Direct	Input
2	Isolated	Coupled
3	GND	GND
4	GND	GND
5	Coupled	Isolated
6	Input	Direct

Dimensions are in Millimeters
Tolerance are Non-Cumulative

Insertion Loss and Power Derating Curves:

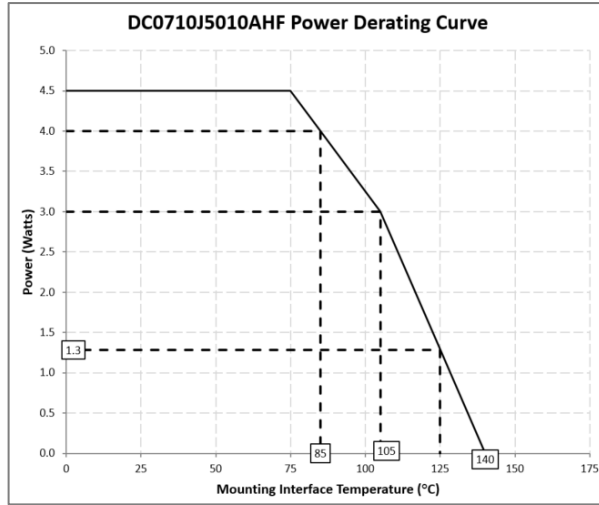
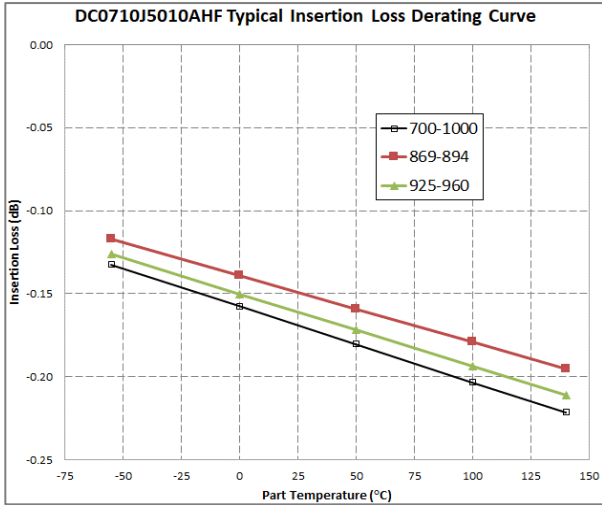

Insertion Loss Derating:

The insertion loss, at a given frequency, of the coupler is measured at 25°C and then averaged. The measurements are performed under small signal conditions (i.e. using a Vector Network Analyzer). The process is repeated at -55°C to 140°C. A best-fit line for the measured data is computed and then plotted from -55°C to 140°C.

Power Derating:

The power handling and corresponding power derating plots are a function of the thermal resistance, mounting surface temperature (base plate temperature), maximum continuous operating temperature of the coupler, and the thermal insertion loss. The thermal insertion loss is defined in the Power Handling section of the data sheet.

As the mounting interface temperature approaches the maximum continuous operating temperature, the power handling decreases to zero.

If mounting temperature is greater than 105°C, the coupler will perform reliably as long as the input power is derated to the curve above.

Typical Performance: 700 MHz to 1000 MHz

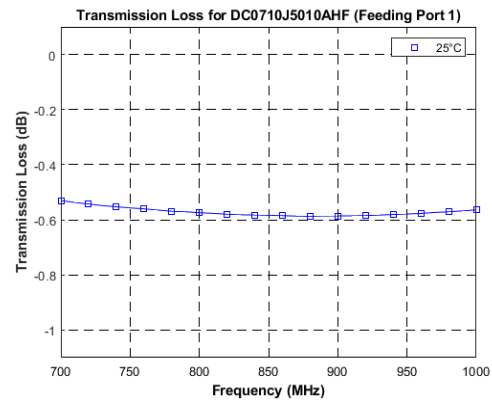
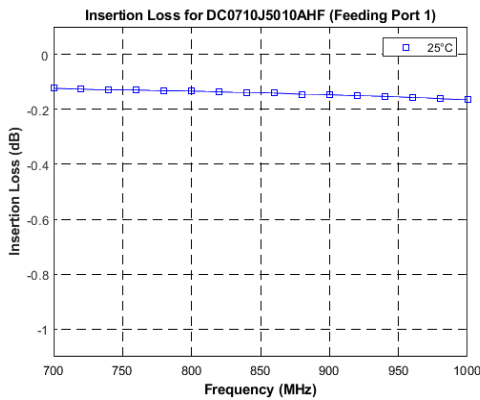
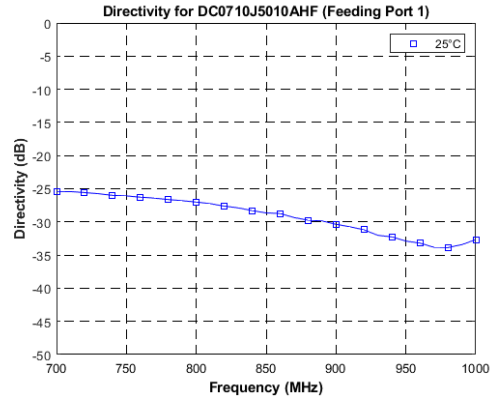
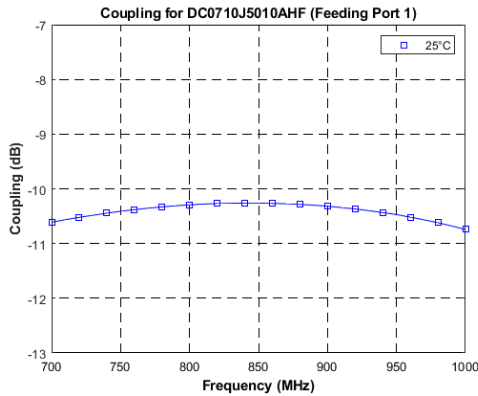
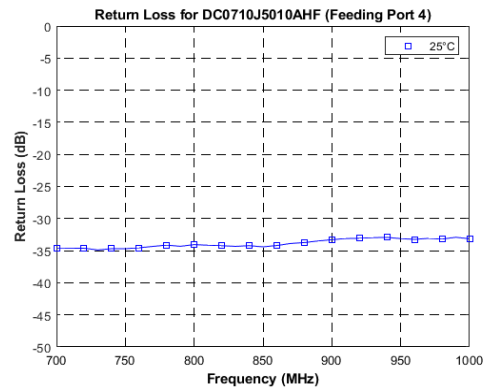
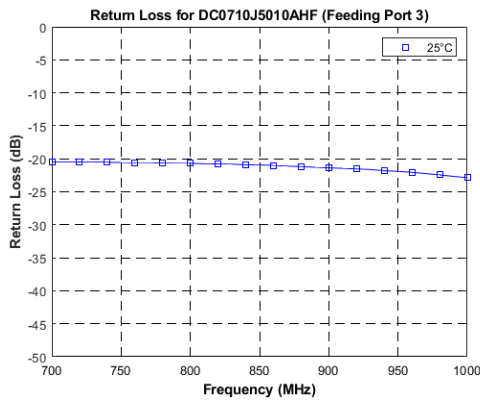
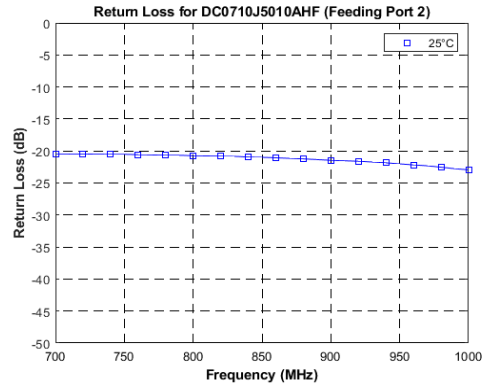
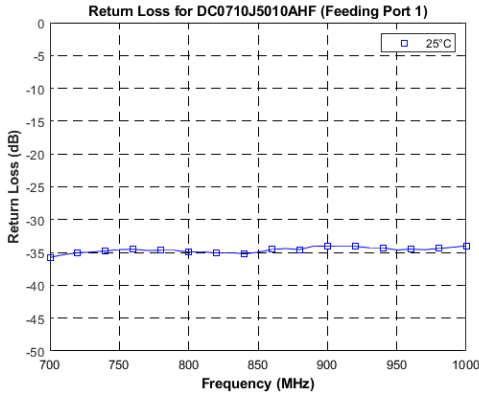

Typical Broadband Performance: 10 to 8010 MHz

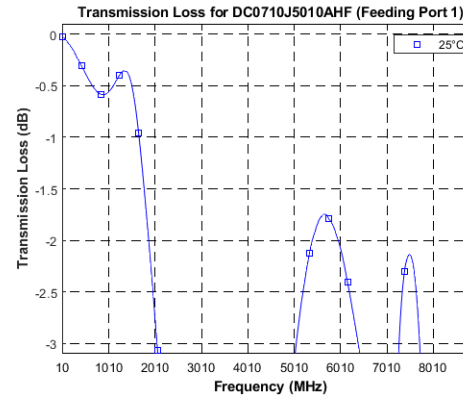
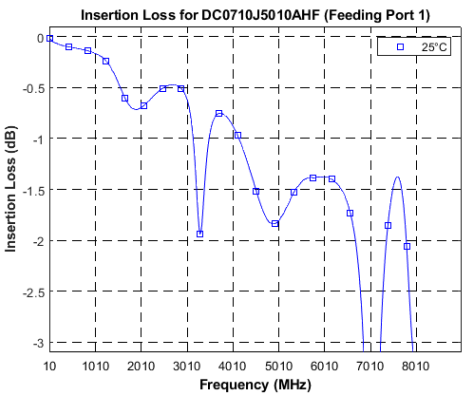
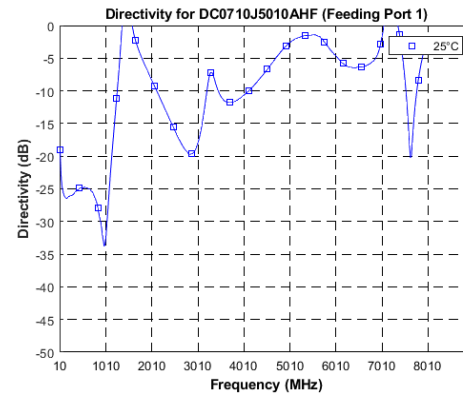
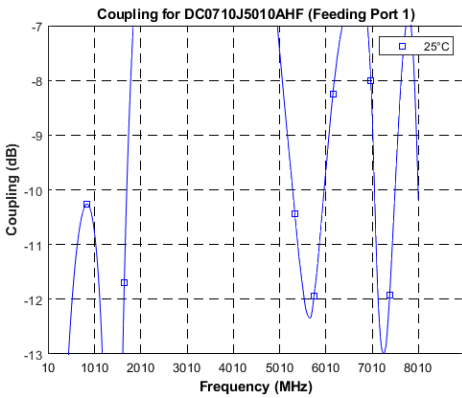
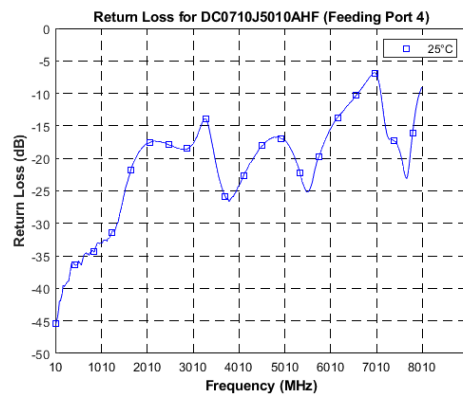
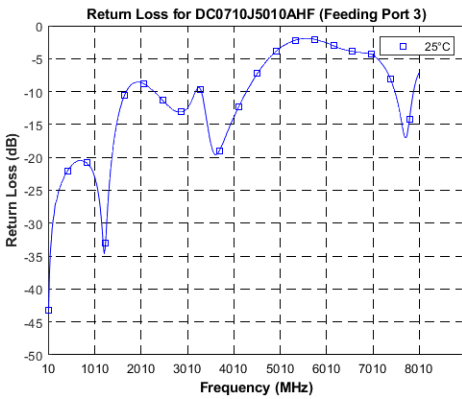
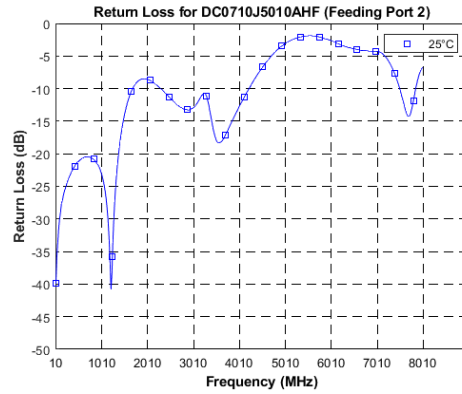
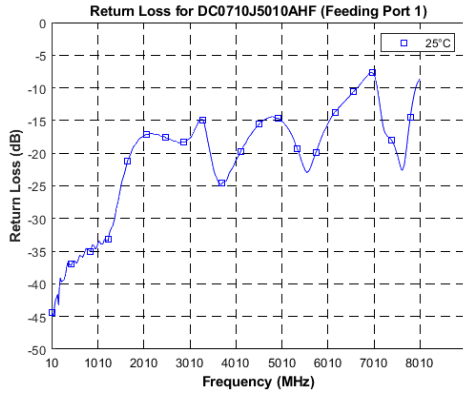

Definition of Measured Specifications:

Parameter	Definition	Mathematical Representation
VSWR (Voltage Standing Wave Ratio)	The impedance match of the coupler to a 50Ω system. A VSWR of 1:1 is optimal.	$VSWR = \frac{V_{max}}{V_{min}}$ Vmax = voltage maxima of a standing wave Vmin = voltage minima of a standing wave
Return Loss	The impedance match of the coupler to a 50Ω system. Return Loss is an alternate means to express VSWR.	$Return\ Loss(dB) = 20\log \frac{VSWR + 1}{VSWR - 1}$
Mean Coupling	At a given frequency (ω_n), coupling is the input power divided by the power at the coupled port. Mean coupling is the average value of the coupling values in the band. N is the number of frequencies in the band.	$Coupling(dB) = C(\omega_n) = 10\log \frac{P_{in}(\omega_n)}{P_{cpl}(\omega_n)}$ $Mean\ Coupling(dB) = \frac{\sum_{n=1}^N C(\omega_n)}{N}$
Insertion Loss	The input power divided by the sum of the power at the two output ports.	$Insertion\ Loss(dB) = 10\log \frac{P_{in}}{P_{cpl} + P_{direct}}$
Transmission Loss	The input power divided by the power at the direct port.	$10\log \frac{P_{in}}{P_{direct}}$
Directivity	The power at the coupled port divided by the power at the isolated port.	$10\log \frac{P_{cpl}}{P_{iso}}$
Frequency Sensitivity	The decibel difference between the maximum in band coupling value and the mean coupling, and the decibel difference between the minimum in band coupling value and the mean coupling.	$Max\ Coupling(dB) - Mean\ Coupling(dB)$ and $Min\ Coupling(dB) - Mean\ Coupling(dB)$
Group Delay	Group delay is average of group delay's from input port to the coupled port	$Average\ (GD - C)$
Group Delay (GD-DC)	Group delay is average of group delay's from input port to the direct port	$Average\ (GD - DC)$

*100% RF test is performed on configuration 1 where port 1 is connected to pin1, port 2 is connected to pin 2, port 3 is connected to pin 5 and port 4 is connected to pin 6.

Peak Power Handling:

High-Pot testing of these components during the qualification procedure resulted in a minimum breakdown voltage of 1Kv (minimum recorded value). This voltage level corresponds to a breakdown resistance capable of handling at least 12dB peak over average power levels, for very short durations. The breakdown location consistently occurred across the pads and the ground pads (see illustration below). The breakdown levels at these points will be affected by any contamination in the gap area around these pads. These areas must be kept clean for optimum performance. It is recommended that the user test for voltage breakdown under the maximum operating conditions and over worst case modulation induced power peaking. This evaluation should also include extreme environmental conditions (such as high humidity).

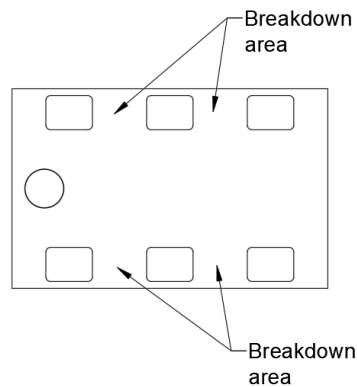

Packaging and Ordering Information:

Parts are available in reel and are packaged per EIA 481. Parts are oriented in tape and reel as shown below. Minimum order quantities are 4000 per reel.

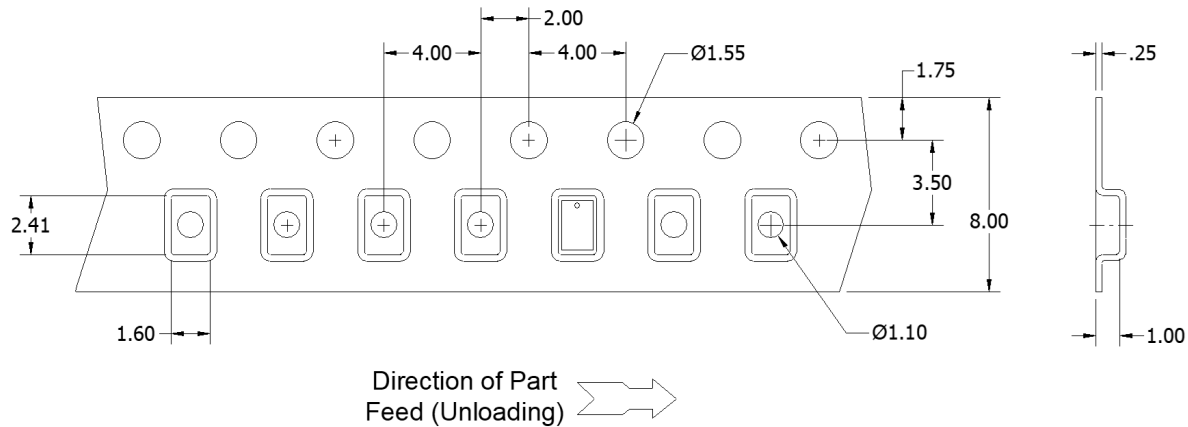

Dimensions are in Millimeters

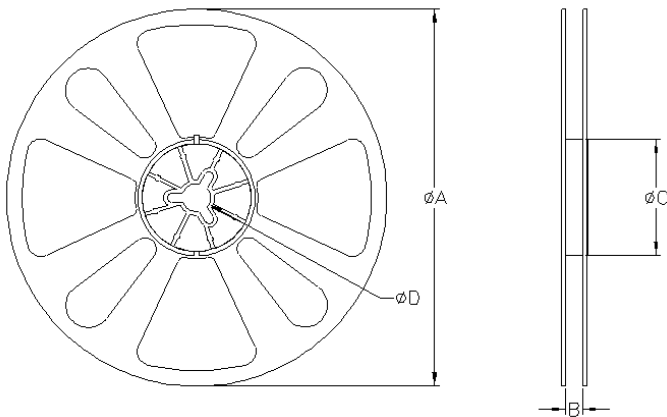

QUANTITY/REEL	REEL DIMENSIONS mm	
4000	ØA	177.80
	B	8.00
	ØC	50.80
	ØD	13.00

Contact us:
rf&s_support@ttm.com