

Xinger^{IV}

Ultra Low Profile 0805 20dB Directional Coupler

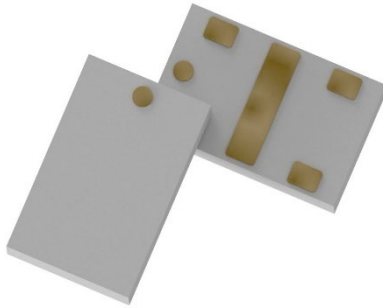

Description:

The X4C20J1-20G is a low cost, low profile sub-miniature high performance 20 dB directional coupler in a new easy to use, manufacturing friendly surface mount package. It is designed for 1400 – 2900MHz applications including: LTE and 5G applications. The X4C20J1-20G is designed particularly for power and frequency detection, as well as for return loss monitoring, where tightly controlled coupling and low insertion loss is required. It can be used in high power applications up to 10 Watts.

Parts have been subjected to rigorous qualification testing and they are manufactured using materials with coefficients of thermal expansion (CTE) compatible with common substrates such as FR4, G-10, RF-35, RO4003 and polyimide. Produced with 6 of 6 RoHS compliant ENIG finish.

Detailed Electrical Specifications:

Features:

- 1400-2900 MHz
- LTE, 5G Applications
- High Power
- Very Low Loss
- High Directivity
- Production Friendly
- Tape and Reel
- RoHS Compliant
- Halogen Free

Frequency MHz	Mean Coupling dB	Insertion Loss dB Max	Return Loss dB Min
1400-1700	21.5 ±1.5	0.1	18
1700-2300	21 ±1.5	0.13	18
2300-2500	21 ±1.5	0.14	18
2296-2890	21.5 ±1.5	0.15	18
2496-2690	21 ±1.5	0.14	18
Directivity dB Min	Frequency Sensitivity dB Max	Power Avg. CW Watts @105 °C	Operating Temp. °C
18	±0.5	10*	-55 to +140
18	±0.35	10*	-55 to +140
18	±0.3	10*	-55 to +140
16	±1.5	10*	-55 to +140
18	±0.4	10*	-55 to +140

**Specification based on performance of unit properly installed on TTM Technologies Test Board with small signal applied.

*Specifications subject to change without notice. Refer to parameter definitions for details.

Outline Drawing:

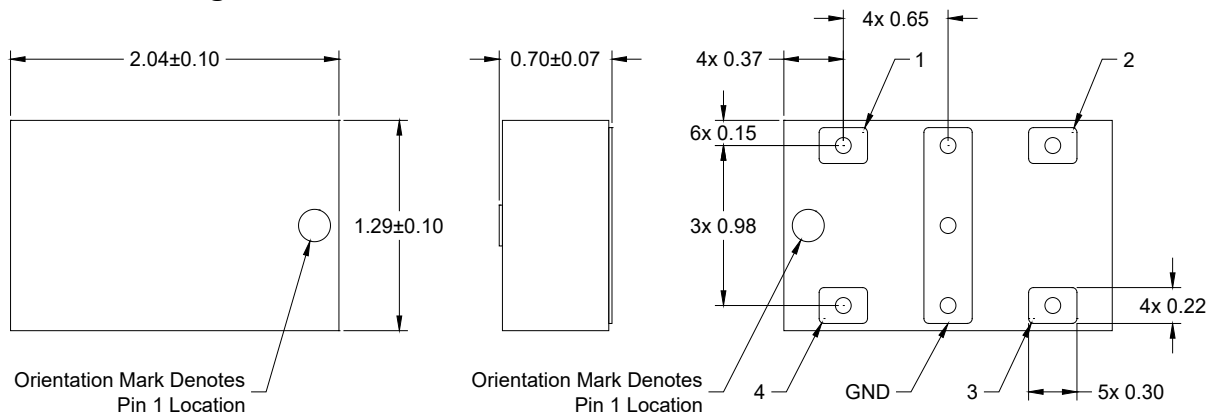

Dimensions are in Millimeters

Tolerances are Non-Cumulative

Directional Coupler Pin Configuration

The X4C20J1-20G has an orientation marker to denote Pin 1. Once port one has been identified the other ports are known automatically. Please see the chart below for clarification:

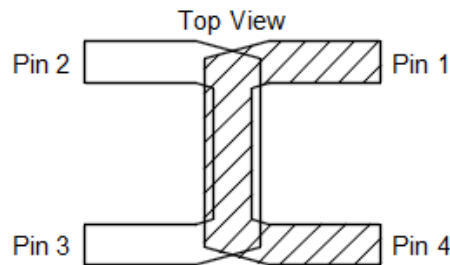

20dB Coupler Pin Configuration

Configuration	Pin 1	Pin 2	Pin 3	Pin 4
Configuration-1	Input	Coupled	Isolated	Direct
Configuration-2	Direct	Isolated	Coupled	Input

Note: The direct port has a DC connection to the input port and the coupled port has a DC connection to the isolated port. For optimum IL and power handling performance, use Pin 1 or Pin 4 as inputs.

Insertion Loss and Power Derating Curves

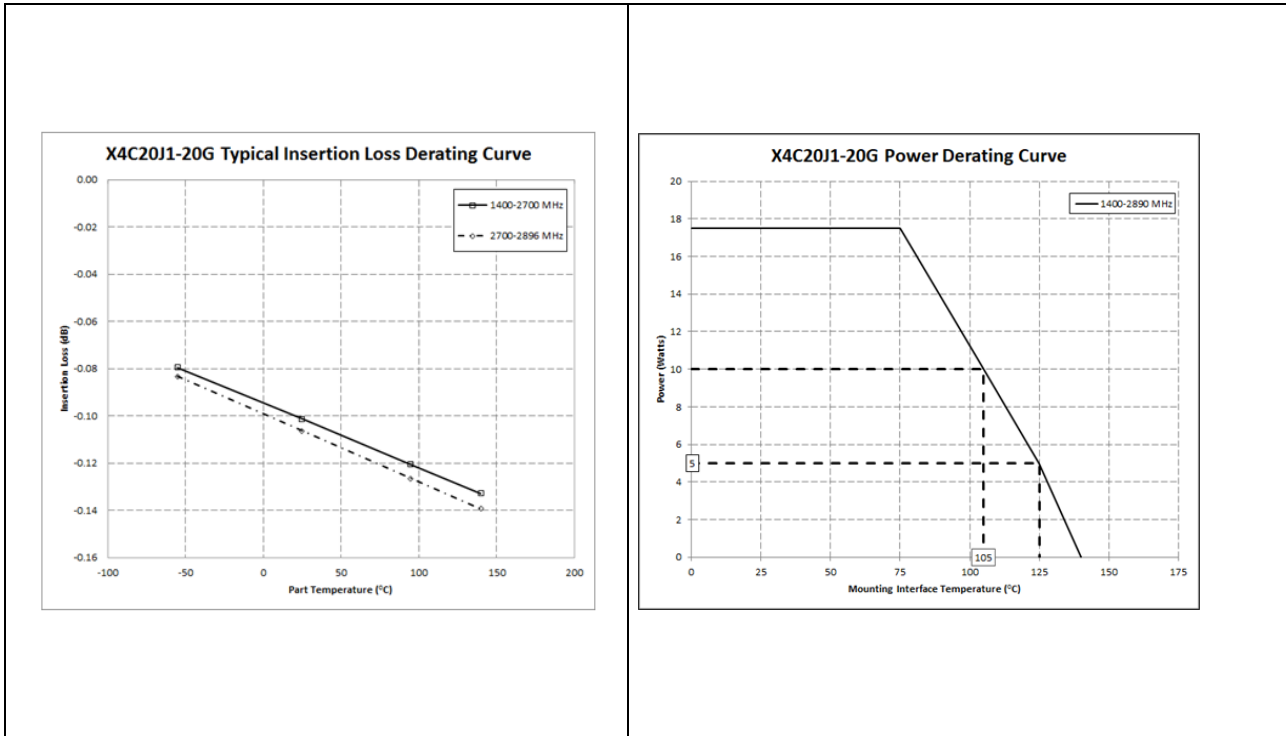

Insertion Loss Derating:

The insertion loss, at a given frequency, of a group of couplers is measured at 25°C and then averaged. The measurements are performed under small signal conditions (i.e. using a Vector Network Analyzer). The process is repeated at -55°C, 105°C and 140°C. A best-fit line for the measured data is computed and then plotted from -55°C to 140°C.

Power Derating:

The power handling and corresponding power derating plots are a function of the thermal resistance, mounting surface temperature (base plate temperature), maximum continuous operating temperature of the coupler, and the thermal insertion loss. The thermal insertion loss is defined in the Power Handling section of the data sheet.

As the mounting interface temperature approaches the maximum continuous operating temperature, the power handling decreases to zero.

If mounting temperature is greater than 105°C, Xinger coupler will perform reliably as long as the input power is derated to the curve above.

Typical Performance: 1400 MHz to 3000 MHz (Configuration 1)

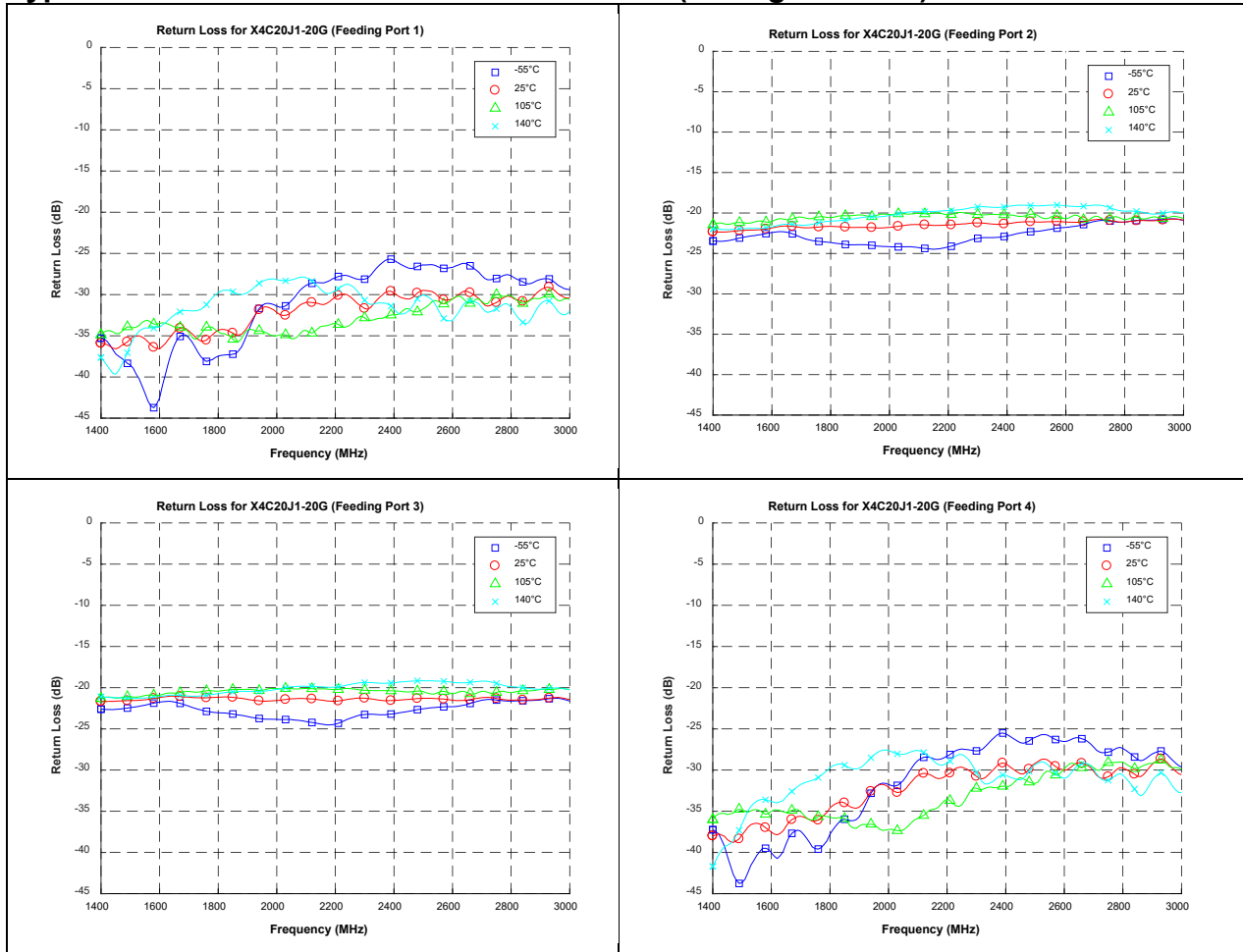

Typical Performance: 1400 MHz to 3000 MHz (Configuration 1)

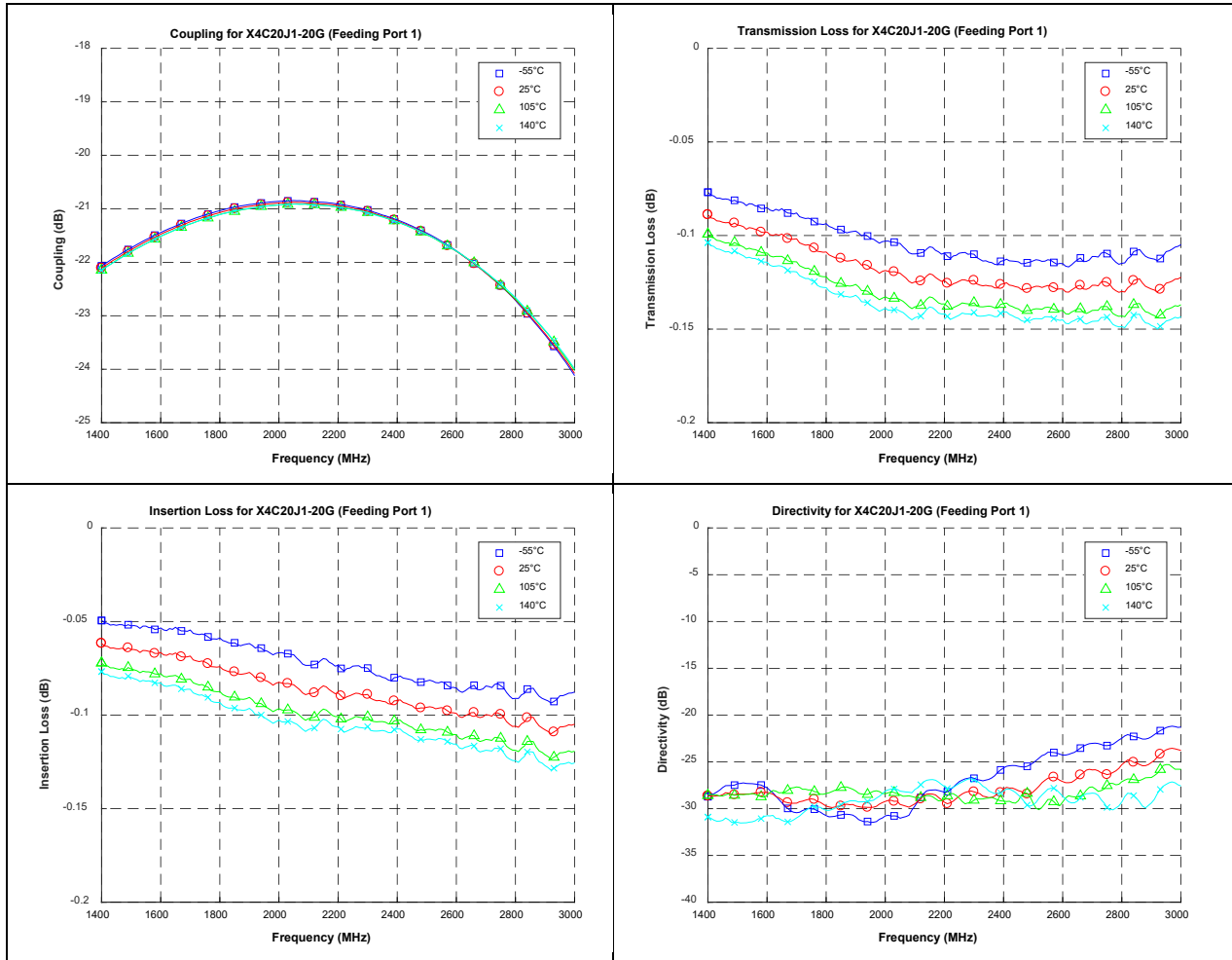

Definition of Measured Specifications

Parameter	Definition	Mathematical Representation
VSWR (Voltage Standing Wave Ratio)	The impedance match of the coupler to a 50Ω system. A VSWR of 1:1 is optimal.	$VSWR = \frac{V_{max}}{V_{min}}$ Vmax = voltage maxima of a standing wave Vmin = voltage minima of a standing wave
Return Loss	The impedance match of the coupler to a 50Ω system. Return Loss is an alternate means to express VSWR.	$Return\ Loss(dB) = 20\log \frac{VSWR + 1}{VSWR - 1}$
Mean Coupling	At a given frequency (ω_n), coupling is the input power divided by the power at the coupled port. Mean coupling is the average value of the coupling values in the band. N is the number of frequencies in the band.	$Coupling(dB) = C(\omega_n) = 10\log \frac{P_{in}(\omega_n)}{P_{cpt}(\omega_n)}$ $Mean\ Coupling(dB) = \frac{\sum_{n=1}^N C(\omega_n)}{N}$
Insertion Loss	The input power divided by the sum of the power at the two output ports.	$Insertion\ Loss(dB) = 10\log \frac{P_{in}}{P_{cpt} + P_{direct}}$
Transmission Loss	The input power divided by the power at the direct port.	$10\log \frac{P_{in}}{P_{direct}}$
Directivity	The power at the coupled port divided by the power at the isolated port.	$10\log \frac{P_{cpt}}{P_{iso}}$
Frequency Sensitivity	The decibel difference between the maximum in band coupling value and the mean coupling, and the decibel difference between the minimum in band coupling value and the mean coupling.	Max Coupling (dB) – Mean Coupling (dB) and Min Coupling (dB) – Mean Coupling (dB)
Group Delay	Group delay is average of group delay's from input port to the coupled port	Average (GD-C)
Group Delay (GD-DC)	Group delay is average of group delay's from input port to the direct port	Average (GD-DC)

*100% RF test is performed per spec definition for pin configuration 1 and 2.

Packaging and Ordering Information

Parts are available in reel and are packaged per EIA 481-D. Parts are oriented in tape and reel as shown below. Minimum order quantities are 4000 per reel.

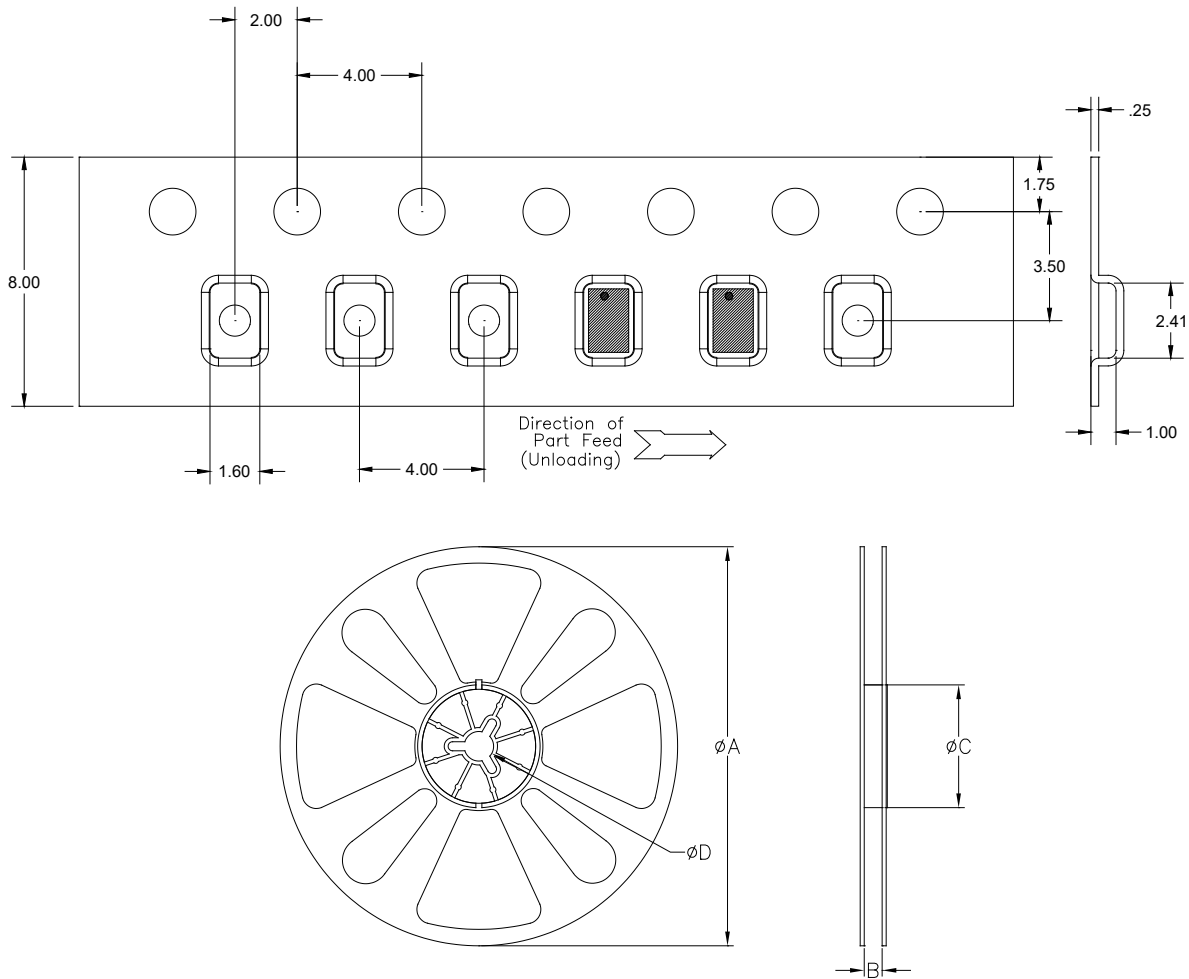

QUANTITY/REEL	REEL DIMENSIONS mm	
4000	ϕA	177.80
	B	8.00
	ϕC	50.80
	ϕD	13.00

Contact us:
rf&s_support@ttm.com