

**10 dB Directional Coupler**

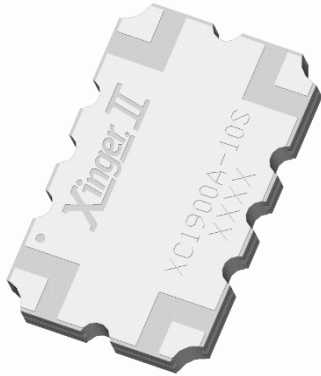

**Description:**

The XC1900A-10S is a low profile, high performance 10dB directional coupler in a new easy to use, manufacturing friendly surface mount package. It is designed for DCS and PCS band applications. The XC1900A-10S is designed particularly for power and frequency detection, as well as for power injection for example in feed-forward, where tightly controlled coupling and low insertion loss is required. It can be used in high power applications up to 175 Watts.

Parts have been subjected to rigorous qualification testing and they are manufactured using materials with coefficients of thermal expansion (CTE) compatible with common substrates such as FR4, G-10, RF-35, RO4350, and polyimide. Available in both 5 of 6 tin lead (XC1900A-10P) and 6 of 6 tin immersion (XC1900A-10S) RoHS compliant finishes.

**Features:**

- 1700 – 2000 MHz
- DCS and PCS
- High Power
- Very Low Loss
- High Directivity
- Tight Coupling
- Production Friendly
- Tape and Reel
- Available in Lead-Free (as illustrated) or Tin-Lead
- Reliable, FIT=0.73

**Electrical Specifications\*\***

Frequency	Mean Coupling	Insertion Loss	VSWR
<i>MHz</i>	<i>dB</i>	<i>dB Max</i>	<i>Max : 1</i>
1700-2000	10.1 ± 0.50	0.16	1.15
1805-1880	10.0 ± 0.40	0.14	1.12
1930-1990	10.0 ± 0.40	0.14	1.12
Frequency Sensitivity	Directivity	Power	Operating Temp.
<i>dB Max</i>	<i>dB Min</i>	<i>Avg. CW Watts@95°C</i>	<i>°C</i>
± 0.10	23	175	-55 to +150
± 0.05	25	175	-55 to +150
± 0.05	25	175	-55 to +150

\*\*Specification based on performance of unit properly installed on TTM Technologies Test Board 54606-0003 with small signal applied. Specifications subject to change without notice. Refer to parameter definitions for details.

**Mechanical Outline:**

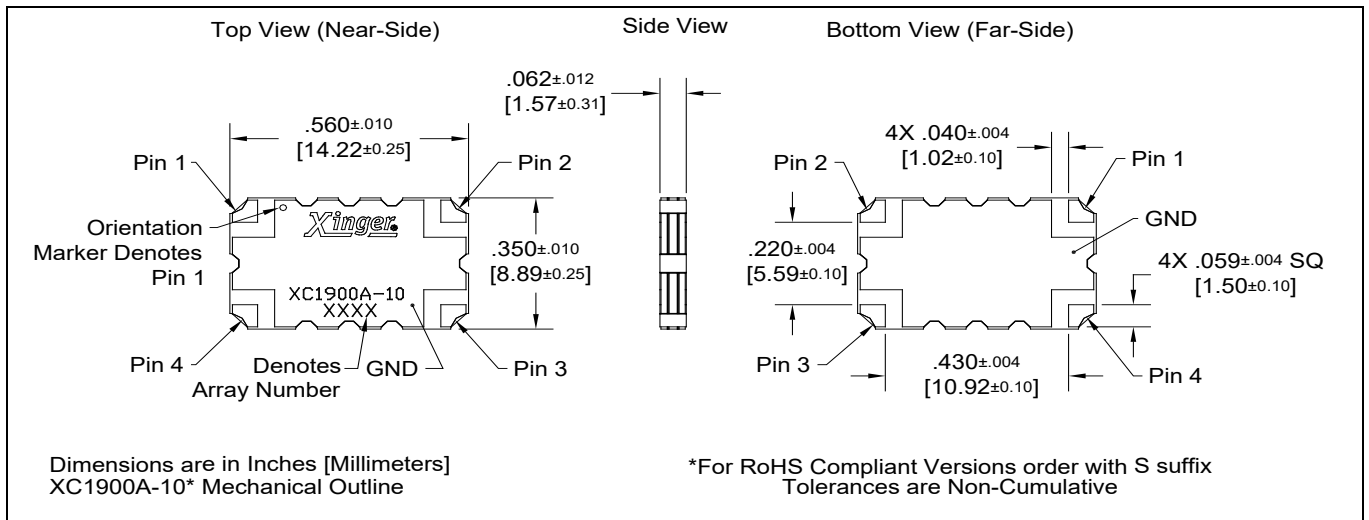

## Directional Coupler Pin Configuration

The XC1900A-10 has an orientation marker to denote Pin 1. Once port one has been identified the other ports are known automatically. Please see the chart below for clarification:

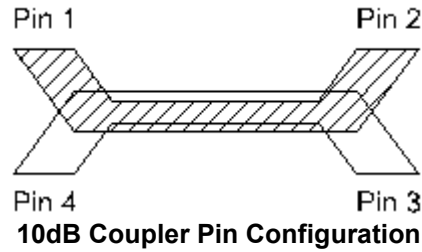

Pin 1	Pin 2	Pin 3	Pin 4
Input	Direct	Isolated	Coupled
Direct	Input	Coupled	Isolated

Note: The direct port has a DC connection to the input port and the coupled port has a DC connection to the isolated port. For optimum performance use Pin 1 or Pin 2 as inputs.

## Peak Power Handling

High-Pot testing of these couplers during the qualification procedure resulted in a minimum breakdown voltage of 1.7KV (minimum recorded value). This voltage level corresponds to a breakdown resistance capable of handling at least 12dB peaks over average power levels, for very short durations. The breakdown location consistently occurred across the air interface at the coupler contact pads (see illustration below). The breakdown levels at these points will be affected by any contamination in the gap area around these pads. These areas must be kept clean for optimum performance. It is recommended that the user test for voltage breakdown under the maximum operating conditions and over worst case modulation induced power peaking. This evaluation should also include extreme environmental conditions (such as high humidity).

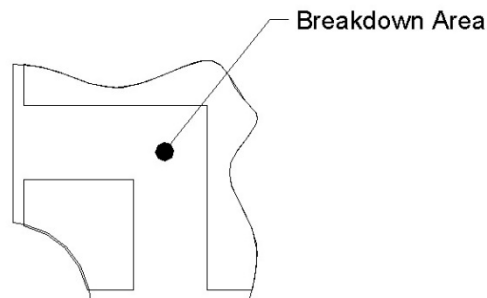

## Insertion Loss and Power Derating Curves

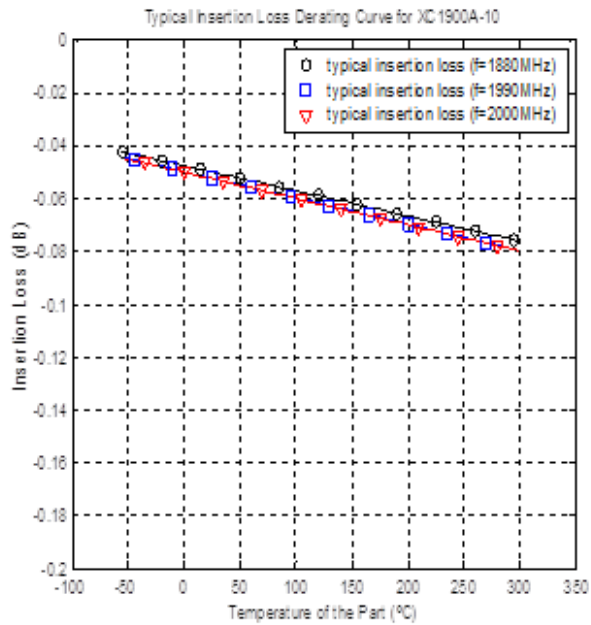

### Insertion Loss Derating

The insertion loss, at a given frequency, of a group of couplers is measured at 25°C and then averaged. The measurements are performed under small signal conditions (i.e. using a Vector Network Analyzer). The process is repeated at 95°C, 150°C, and 200°C. A best-fit line for the measured data is computed and then plotted from -55°C to 300°C.

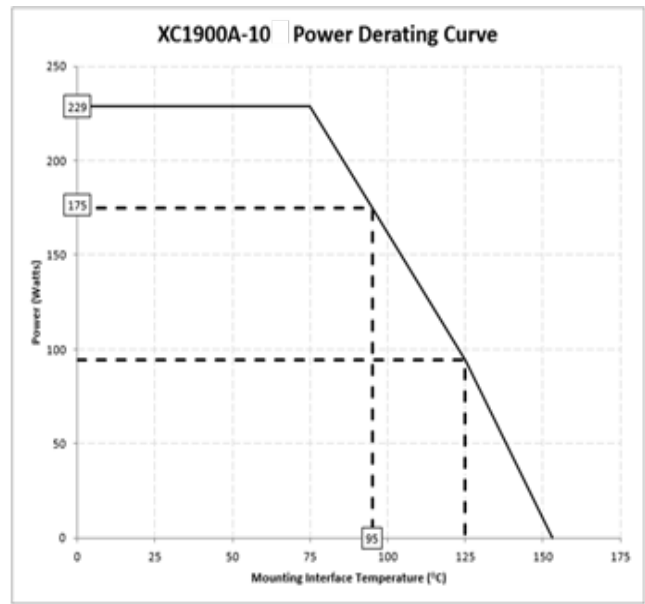

### Power Derating

The power handling and corresponding power derating plots are a function of the thermal resistance, mounting surface temperature (base plate temperature), maximum continuous operating temperature of the coupler, and the thermal insertion loss. The thermal insertion loss is defined in the Power Handling section of the data sheet.

As the mounting interface temperature approaches the maximum continuous operating temperature, the power handling decreases to zero.

**Typical Performance (-55°C, 25°C and 95°C): 1700-2000 MHz**

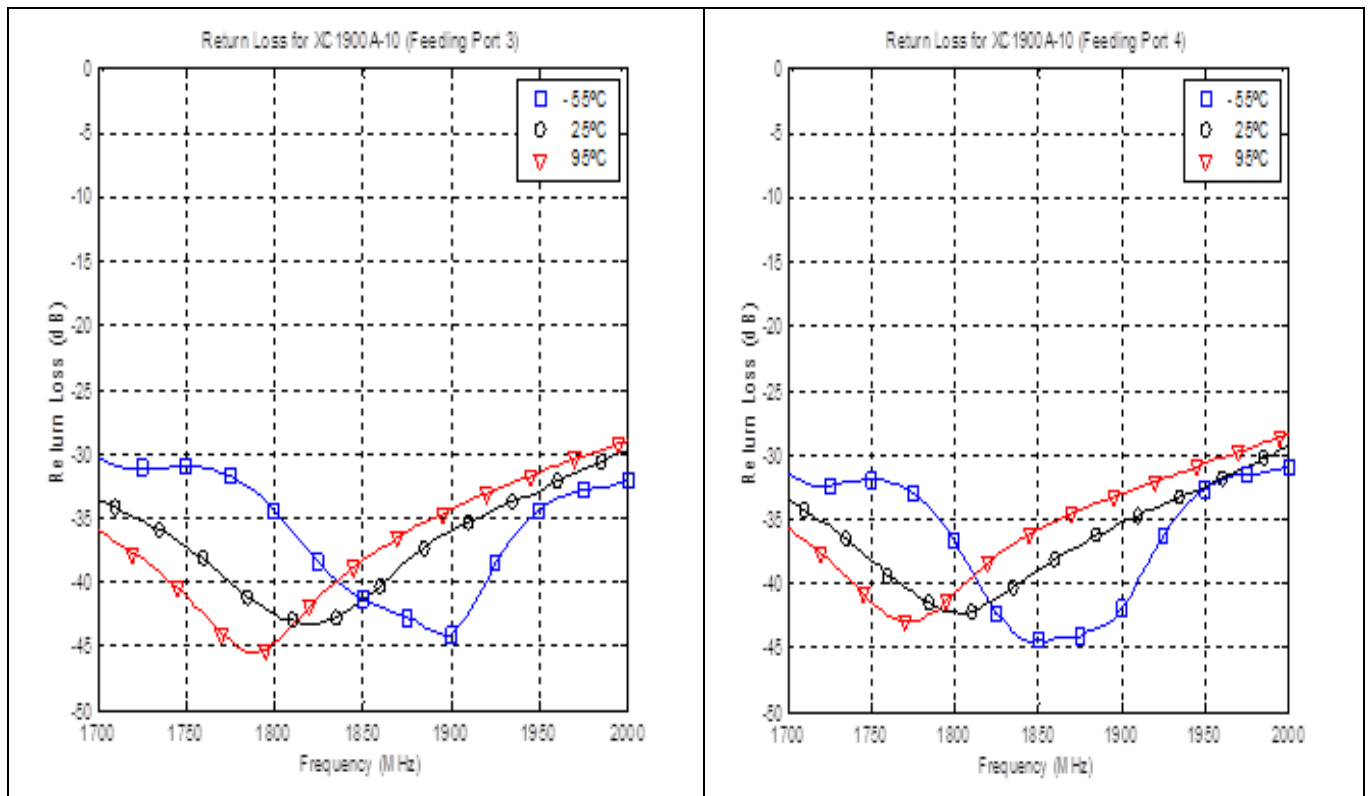
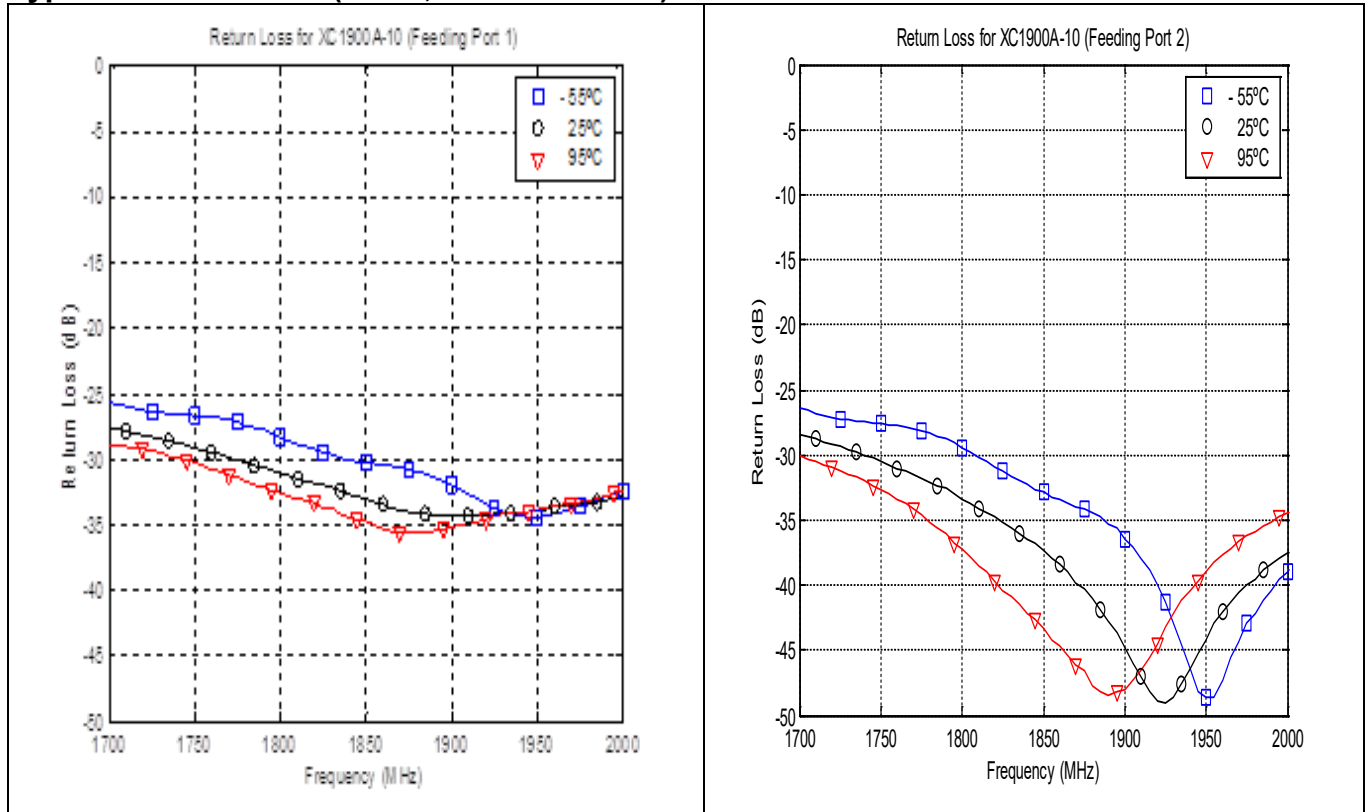

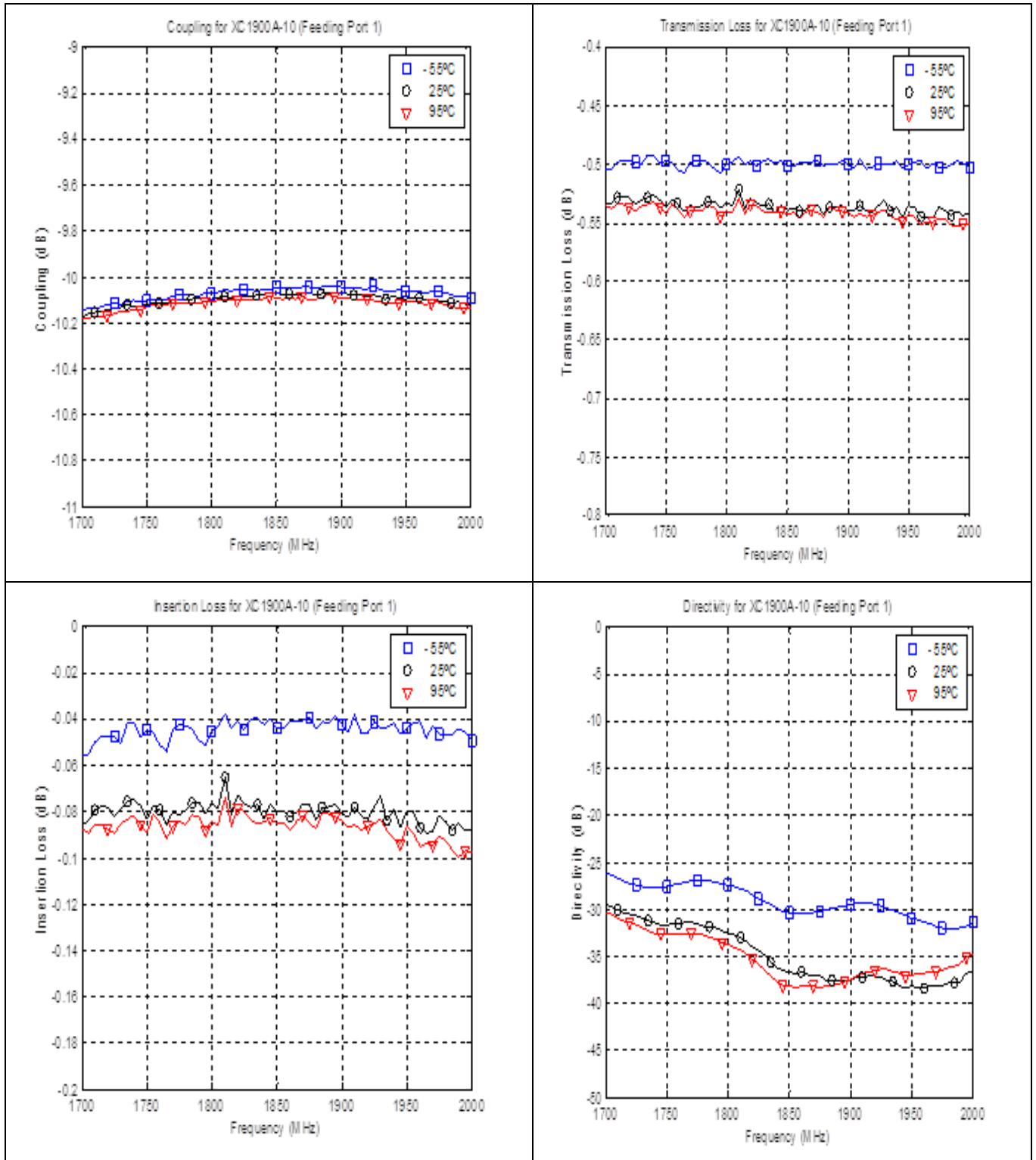

### Definition of Measured Specification

Parameter	Definition	Mathematical Representation
<b>VSWR</b> <b>(Voltage Standing Wave Ratio)</b>	The impedance match of the coupler to a 50Ω system. A VSWR of 1:1 is optimal.	$VSWR = \frac{V_{max}}{V_{min}}$ Vmax = voltage maxima of a standing wave Vmin = voltage minima of a standing wave
<b>Return Loss</b>	The impedance match of the coupler to a 50Ω system. Return Loss is an alternate means to express VSWR.	$Return\ Loss(dB) = 20\log \frac{VSWR + 1}{VSWR - 1}$
<b>Mean Coupling</b>	At a given frequency ( $\omega_n$ ), coupling is the input power divided by the power at the coupled port. Mean coupling is the average value of the coupling values in the band. N is the number of frequencies in the band.	$Coupling(dB) = C(\omega_n) = 10\log \frac{P_{in}(\omega_n)}{P_{cpl}(\omega_n)}$ $Mean\ Coupling(dB) = \frac{\sum_{n=1}^N C(\omega_n)}{N}$
<b>Insertion Loss</b>	The input power divided by the sum of the power at the two output ports.	$10\log \frac{P_{in}}{P_{cpl} + P_{direct}}$
<b>Transmission Loss</b>	The input power divided by the power at the direct port.	$10\log \frac{P_{in}}{P_{direct}}$
<b>Directivity</b>	The power at the coupled port divided by the power at the isolated port.	$10\log \frac{P_{cpl}}{P_{iso}}$
<b>Frequency Sensitivity</b>	The decibel difference between the maximum in band coupling value and the mean coupling, and the decibel difference between the minimum in band coupling value and the mean coupling.	Max Coupling (dB) – Mean Coupling (dB) and Min Coupling (dB) – Mean Coupling (dB)

**Packaging and Ordering Information:**

Parts are available in both reel and tube. Packaging follows EIA 481-2. Parts are oriented in tape and reel as shown below. Minimum order quantities are 2000 per reel and 30 per tube. See Model Numbers below for further ordering information.

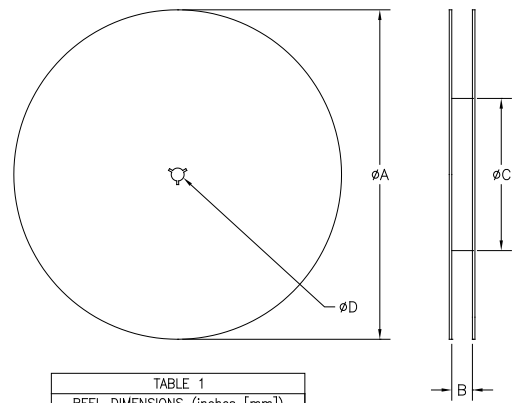
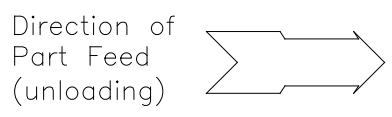
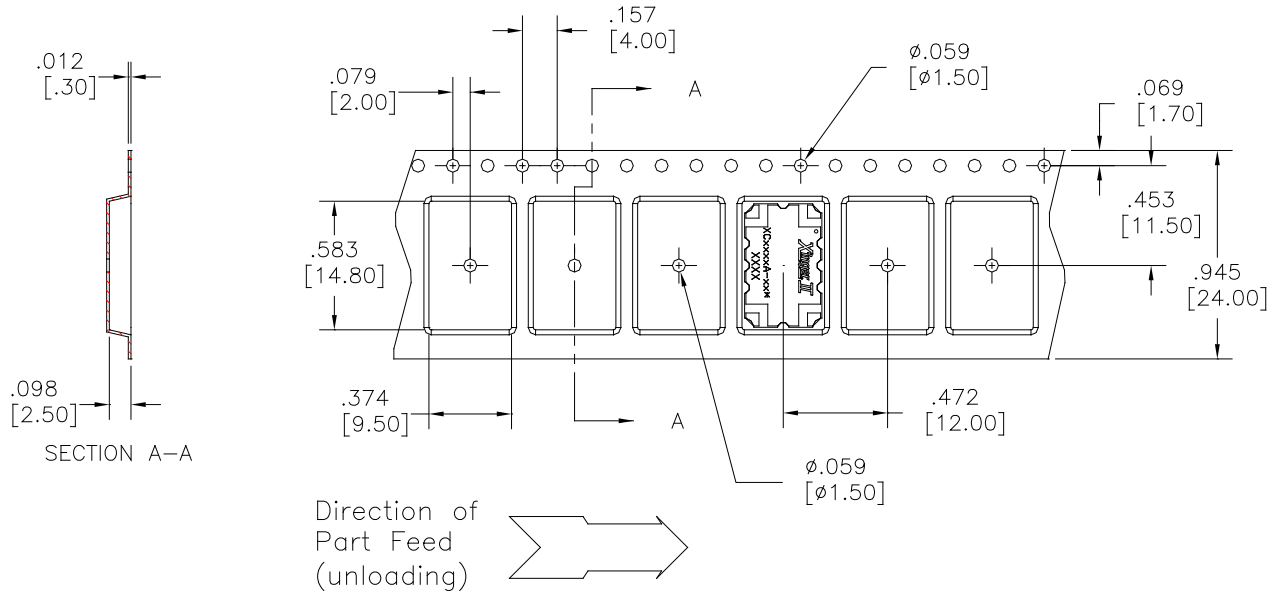

TABLE 1	
REEL DIMENSIONS (inches [mm])	
$\phi A$	13.3 [333.0]
B	0.945 [24.0]
$\phi C$	4.017 [102.03]
$\phi D$	0.512 [13.0]

**Contact us:**  
[rf&s\\_support@ttm.com](mailto:rf&s_support@ttm.com)