

**Description:**

The X4DS50Z1-100G is a low cost, low profile 3dB 50 Ohm single-ended and 100 Ohm differential splitter in a new easy to use, Xinger style manufacturing friendly surface mount package. X4DS50Z1-100G has a power rating of 1 Watts (AVG) and a peak to average ratio of 12dB. It is designed particularly for all end markets in Telecom and COTS Mil-Aero applications. The X4DS50Z1-100G can be used for differential signal distribution for local oscillator distribution without the need for transforming to single ended and transforming back to differential, This product also consist of 2 isolated couplers and can be used for a wide variety of other splitting and combining applications.

Parts have been subjected to rigorous Xinger qualification testing and they are manufactured using materials with coefficients of thermal expansion (CTE) compatible with common substrates such as FR4, RF-35, RO4350 and polyimide. Produced with 6 of 6 RoHS compliant ENIG finish.

**Features:**

- 4800-5000 MHz
- 0.64mm Height Profile
- 50 Ohm Single-Ended
- Power 1W (AVG)
- Peak to Average Ratio 12dB
- All end markets in Telecom and COTS Mil-Aero
- Very Low Loss (<0.6dB)
- Tight Amplitude Balance ( $\pm 0.30$ dB)
- Production Friendly
- Tape and Reel

**Electrical Specifications\***

Frequency	Isolation	Insertion Loss	Return Loss	Amplitude Balance
MHz	dB Min	dB Max	dB Min	dB
4800-5000	18	0.6	18	$\pm 0.30$
Amplitude Match	Phase Balance	Phase Match	Power	Operating Temp.
dB	Degrees	Degrees	Avg. Watts@105°C	°C
$\pm 0.25$	90 $\pm 5.0$	$\pm 7.0$	1	-55 to 140

\*Specification based on performance of unit properly installed on a TTM test board with small signal applied. Specifications subject to change without notice. Refer to parameter definitions for details.

**Mechanical Outline:**

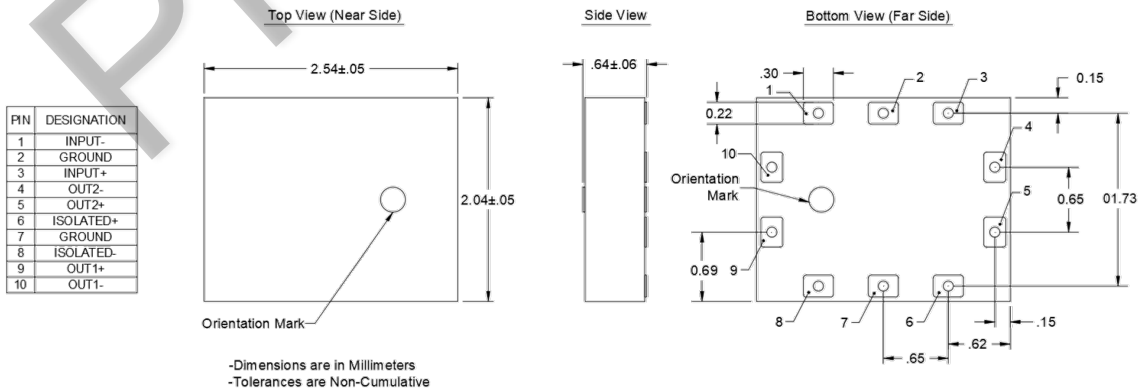

**Differential Splitter Pin Configuration:**

The X4DS50Z1-100G has an orientation marker to denote "Input-" port. Once port one has been identified the other ports are known automatically. Please see the chart below for clarification:

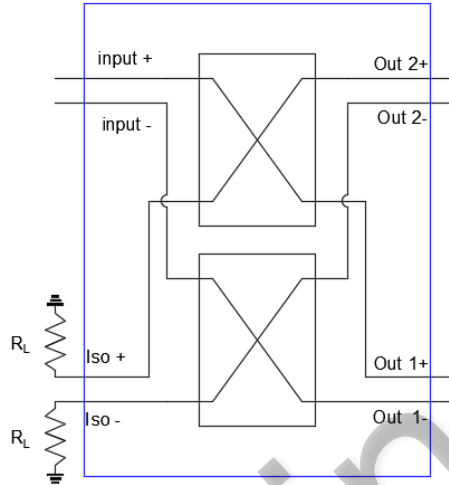

**Differential Splitter Pin Configuration:**

Input +	ISO +	Out1 +	Out2 +
Input +	Terminated	-3dB $\angle$ $\theta$ -90 (of input+)	-3dB $\angle$ $\theta$ (of input+)

Input -	ISO -	Out1 -	Out2 -
Input -	Terminated	-3dB $\angle$ $\theta$ -90 (of input-)	-3dB $\angle$ $\theta$ (of input-)

## Insertion Loss and Power Derating Curves:

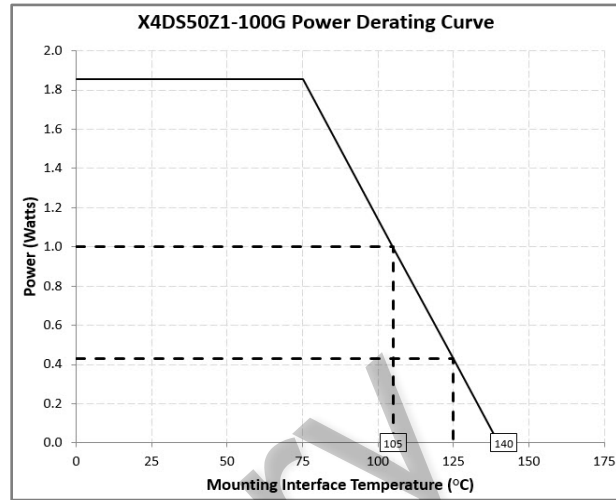
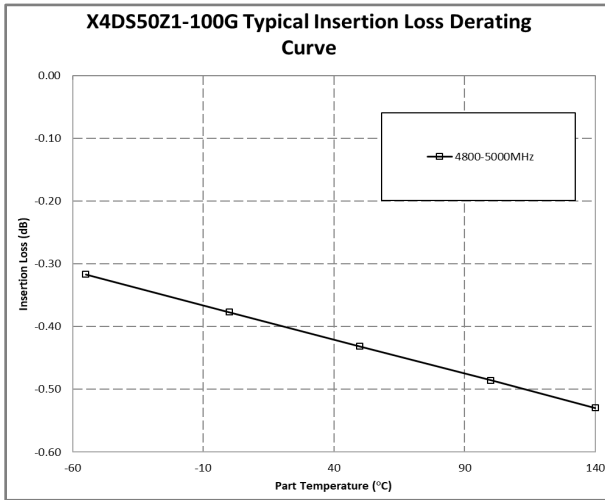

### Insertion Loss Derating:

The insertion loss, at a given frequency, of the differential splitter is measured at 25°C and then averaged. The measurements are performed under small signal conditions (i.e. using a Vector Network Analyzer). The process is repeated at temperatures from -55 to 140°C. A best-fit line for the measured data is computed and then plotted from -55°C to 140°C.

### Power Derating:

The power handling and corresponding power derating plots are a function of the thermal resistance, mounting surface temperature (base plate temperature), maximum continuous operating temperature of the differential splitter, and the thermal insertion loss. The thermal insertion loss is defined in the Power Handling section of the data sheet.

As the mounting interface temperature approaches the maximum continuous operating temperature, the power handling decreases to zero.

If mounting temperature is greater than 105°C, the Xinger differential splitter will perform reliably as long as the input power is derated to the curve above.

### Definition of Measured Specifications:

Parameter	Definition	Mathematical Representation
<b>Return Loss</b>	The impedance match at the single ended port.	$RL = 20\text{Log}_{10}(S_{nn}); n = 1 \text{ to } 8$
<b>Insertion Loss</b>	The input power divided by the sum of the power at the two output ports.	$IL\ 1 = 20\text{Log}_{10}(S_{31} + S_{81})$ $IL\ 2 = 20\text{Log}_{10}(S_{42} + S_{72})$
<b>Isolation</b>	The input power divided by the power at the isolated port.	$ISO\ 1 = 20\text{Log}_{10}(S_{61})$ $ISO\ 2 = 20\text{Log}_{10}(S_{52})$
<b>Amplitude Balance</b>	The ratio of the power at output ports corresponding to same input port.	$AB1 = 20\text{Log}_{10}\left \frac{S_{72}}{S_{42}}\right $ $AB2 = 20\text{Log}_{10}\left \frac{S_{81}}{S_{31}}\right $
<b>Amplitude Match</b>	The ratio of power between one output differential pair.	$AM1 = 20\text{Log}_{10}\left \frac{S_{81}}{S_{72}}\right $ $AM2 = 20\text{Log}_{10}\left \frac{S_{31}}{S_{42}}\right $
<b>Phase Balance</b>	The difference in phase angle between the two output ports corresponding to same input port.	$PB1 = (\text{Phase}(S_{72}) - \text{Phase}(S_{42}))$ $PB2 = (\text{Phase}(S_{81}) - \text{Phase}(S_{31}))$
<b>Phase Match</b>	The difference in phase angle between one differential pair.	$PM1 = (\text{Phase}(S_{81}) - \text{Phase}(S_{72}))$ $PM2 = (\text{Phase}(S_{31}) - \text{Phase}(S_{42}))$

\*100% RF test is performed per spec definition for every pin configuration. Refer to page 2 for pin assignment.

### S parameter Port Mapping:

Pin Number	Port Number	Functionality
1	1	INPUT -
2	NA	Ground
3	2	INPUT +
4	3	OUT 2 -
5	4	OUT 2 +
6	5	ISOLATED +
7	NA	Ground
8	6	ISOLATED -
9	7	OUT 1 +
10	8	OUT 1 -

### Peak Power Handling:

High-Pot testing of these components during the qualification procedure resulted in a minimum breakdown voltage of 1Kv (minimum recorded value). This voltage level corresponds to a breakdown resistance capable of handling at least 12dB peak over average power levels, for very short durations. The breakdown location consistently occurred across the pads and the ground bar. The breakdown levels at these points will be affected by any contamination in the gap area around these pads. These areas must be kept clean for optimum performance. It is recommended that the user test for voltage breakdown under the maximum operating conditions and over worst case modulation induced power peaking. This evaluation should also include extreme environmental conditions (such as high humidity).

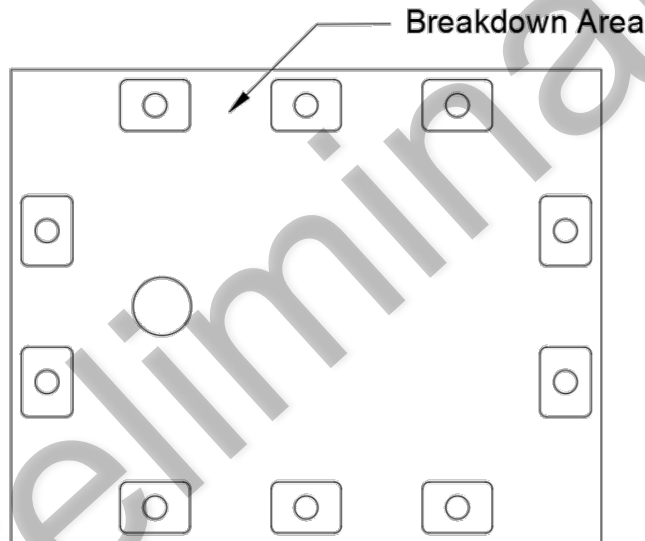

**Packaging and Ordering Information:**

Parts are available in reel and are packaged per EIA 481. Parts are oriented in tape and reel as shown below. Minimum order quantities are 4000 per reel.

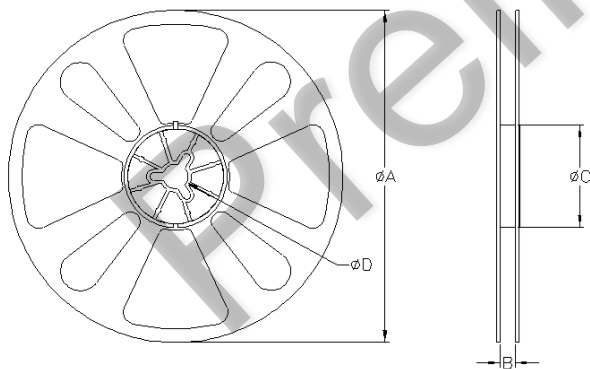
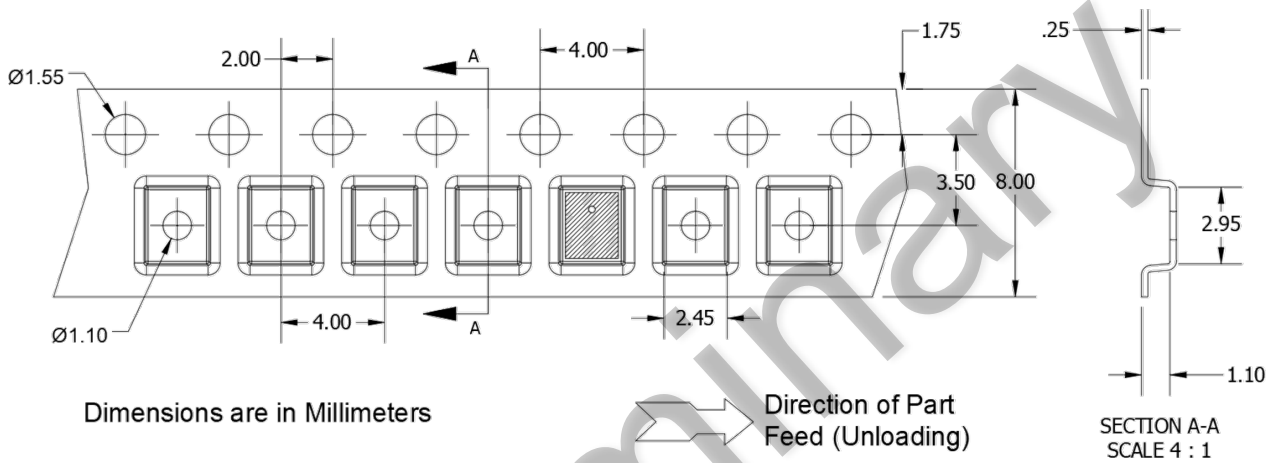

TABLE 1		
QUANTITY/REEL	REEL DIMENSIONS mm	
4000	ØA	177.80
	B	8.00
	ØC	50.80
	ØD	13.00

**Contact us:**  
[rf&s\\_support@ttm.com](mailto:rf&s_support@ttm.com)