

# Xinger®

## Ultra Low Profile 0603 Power Divider 50Ω to 50Ω

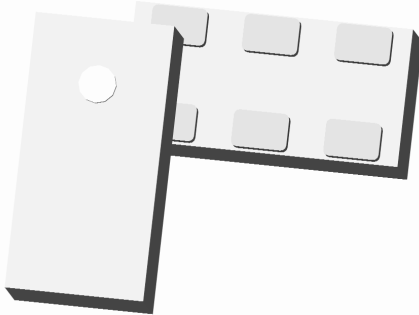

### Description

The PD4859L5050S2HF is a low profile, sub-miniature Wilkinson power divider in an easy to use surface mount package. The PD4859L5050S2HF is ideal for high volume manufacturing and delivers higher performances than traditional printed and lumped element solutions. The PD4859L5050S2HF is matched to 50 Ω and has a height profile of 65mm, which is ideal for high-level integrations in the following markets: 5G, LTE. The PD4859L5050S2HF does not include the resistive element and therefore, requires an external resistor for operation. The PD4859L5050S2HF is available on tape and reel for high volume manufacturing pick and place.

### Detailed Electrical Specifications: Specifications subject to change without notice.

Parameter	ROOM (25 °C)												Unit
	Min.	Typ.	Max	Min.	Typ.	Max	Min.	Typ.	Max	Min.	Typ.	Max	
Frequency	3000		6000	3900		4100	4600		5200	4800		6200	MHz
Input Port Impedance		50			50			50			50		Ω
Output Port Impedance		50			50			50			50		Ω
Return Loss	10	10.5		11	13		14	15		12	15		dB
Insertion Loss*		0.6	0.7		0.4	0.6		0.4	0.5		0.5	0.7	dB
Amplitude Balance		0.05	0.3		0.06	0.2		0.05	0.2		0.03	0.3	dB
Phase Balance		0.7	2		0.5	2.2		0.7	2		0.3	2	Degrees
Isolation (Output Ports)	9	10		13	15		19	20		17	19		dB
Power Handling @85C			2			2			2			2	Watts
Operating Temperature	-55		140	-55		140	-55		140	-55		140	°C

\* Insertion Loss stated at room temperature (Insertion Loss is approximately 0.1 dB higher at +85 °C)

### Outline Drawing

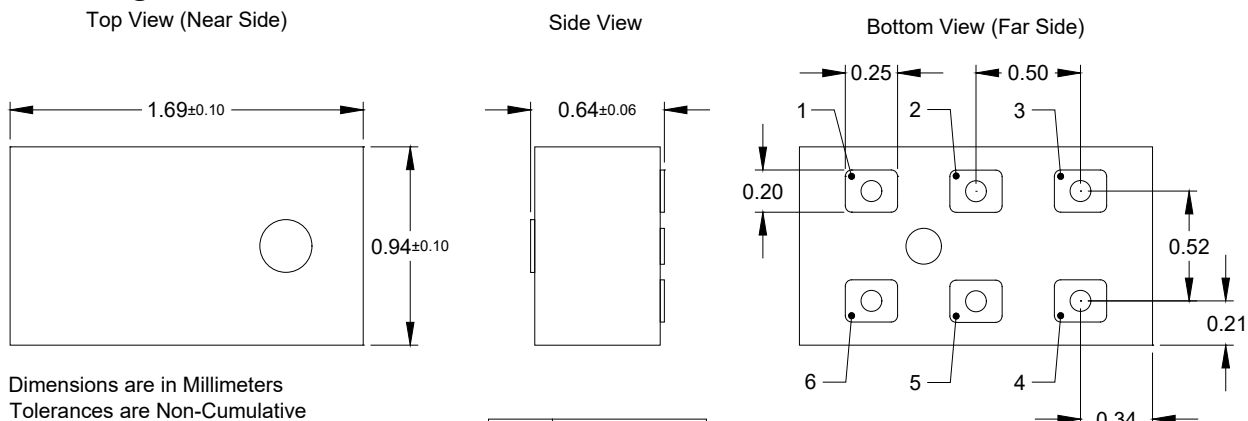

Dimensions are in Millimeters  
Tolerances are Non-Cumulative

Pin	Designation
1	Ground
2	Input
3	Ground
4	Output 1
5	Ground
6	Output 2

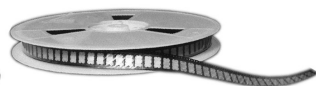

## Typical Broadband Performance: 500 MHz to 7500 MHz

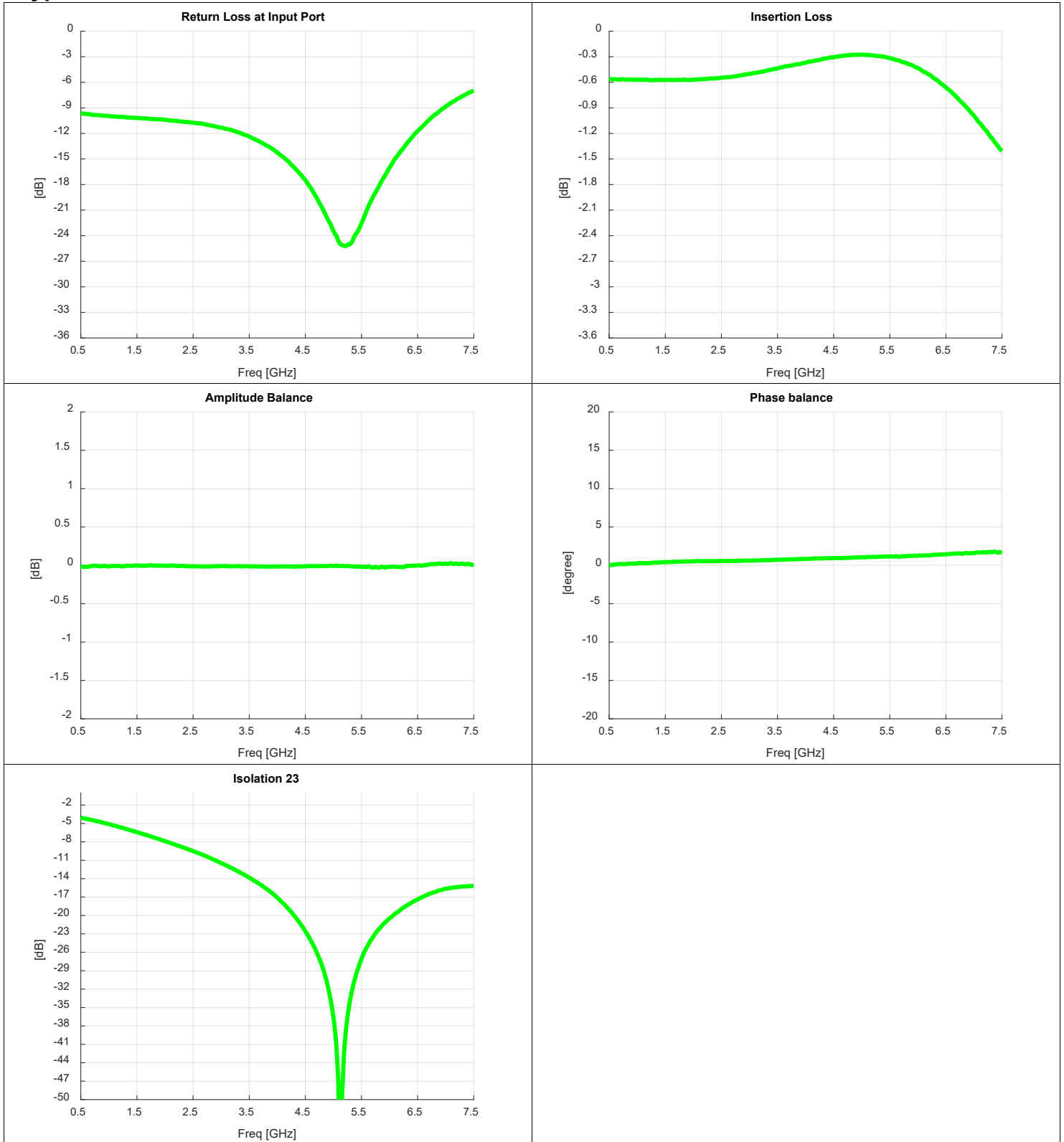

USA/Canada: (315) 233-5510  
 Toll Free: (833) 389-6402  
 Europe: +44 2392-232392  
 Asia: +86 512 62749282

Available on Tape and Reel for Pick and Place Manufacturing.

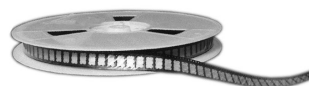

### Typical Performance: 3000 MHz to 6200 MHz

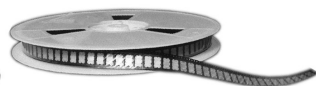
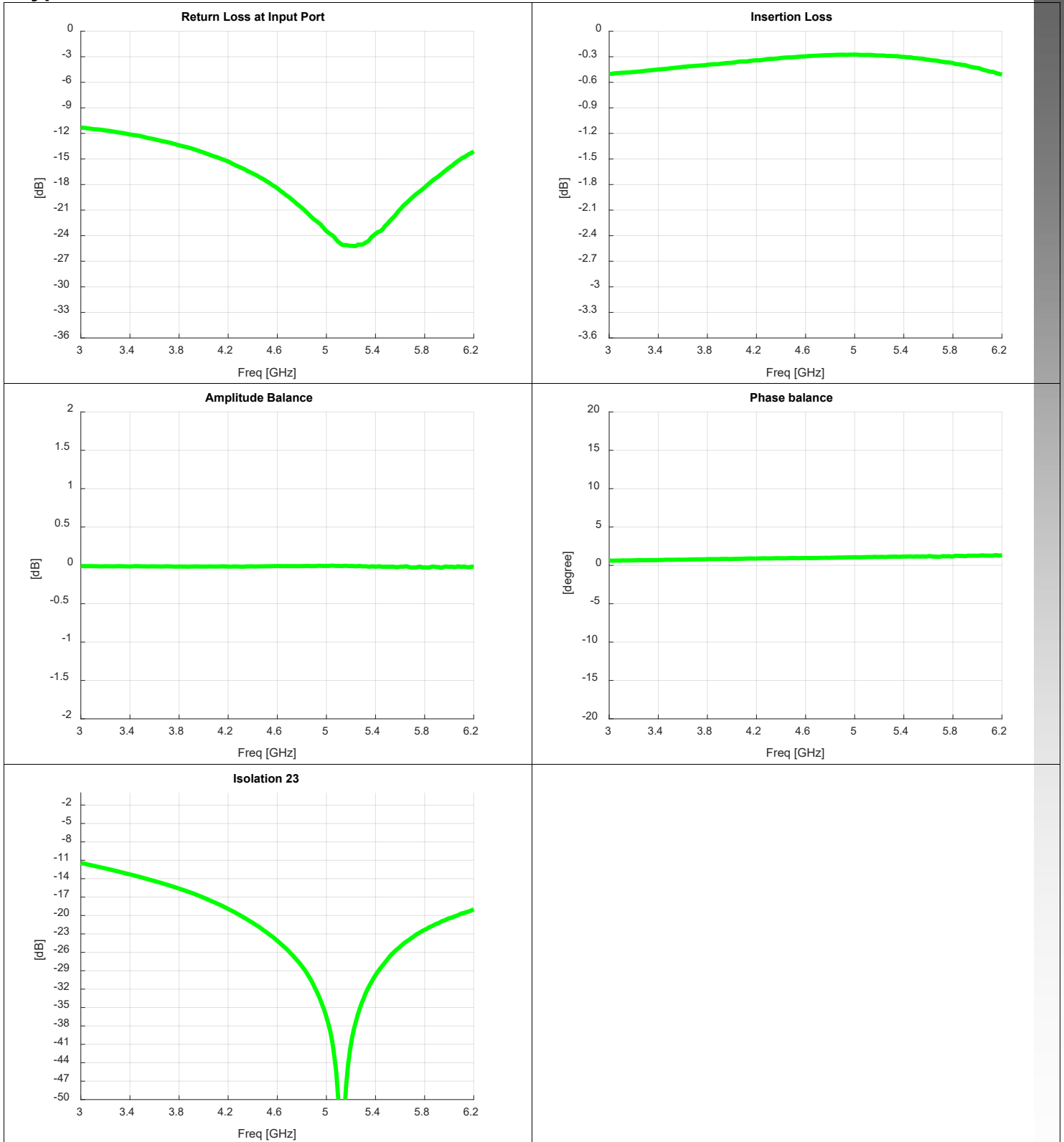

## Mounting Configuration:

In order for Xinger surface mount components to work optimally, the proper impedance transmission lines must be used to connect to the RF ports. If this condition is not satisfied, insertion loss, Isolation and VSWR may not meet published specifications.

An example of the PCB footprint used in the testing of these parts is shown below. In specific designs, the transmission line widths need to be adjusted to the unique dielectric coefficients and thicknesses as well as varying pick and place equipment tolerances. In addition, since the PD4859L050S2HF is a Wilkinson power divider, an external 0402 100Ω resistor must be mounted in locations R1 as shown in the Figure below.

All of the Xinger components are constructed from organic PTFE based composites which possess excellent electrical and mechanical stability. Xinger components are compliant to a variety of ROHS and Green standards and ready for Pb-free soldering processes. Pads are Gold plated with a Nickel barrier.

In specific designs, the transmission line widths need to be adjusted to the unique dielectric coefficients and thicknesses as well as varying pick and place equipment tolerances.

## Pad Footprint w/ 0402 Resistor Location

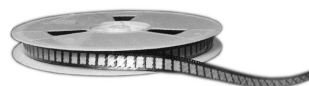
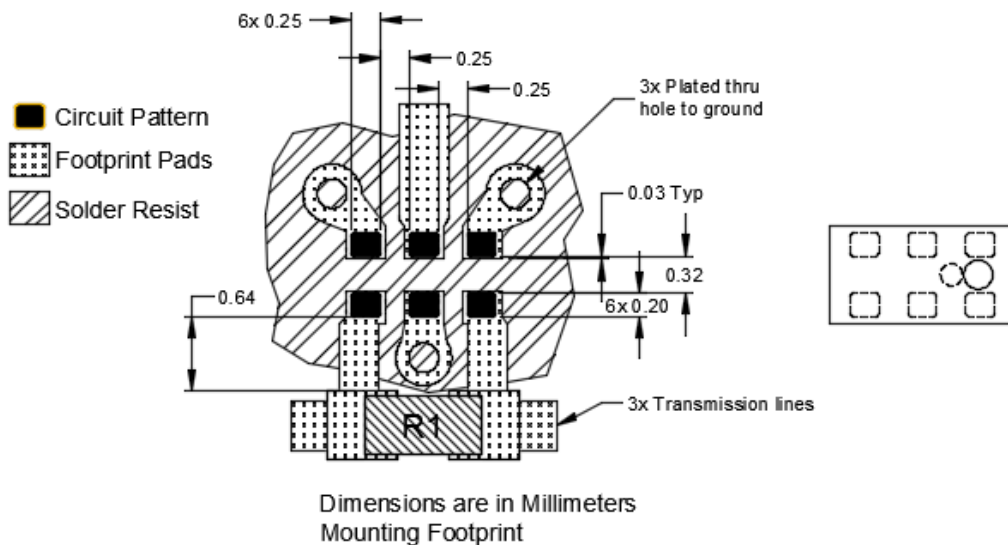

### Packaging and Ordering Information

Parts are available in reel and are packaged per EIA 481-D. Parts are oriented in tape and reel as shown below. Minimum order quantities are 4000 per reel.

